

---

## UDP C8051F960/Si1020 MCU CARD WITH EMIF USER'S GUIDE

---

### 1. Introduction

The Unified Development Platform (UDP) provides a development and demonstration platform for Silicon Laboratories microcontrollers and the Silicon Laboratories software tools, including the Silicon Laboratories Integrated Development Environment (IDE).

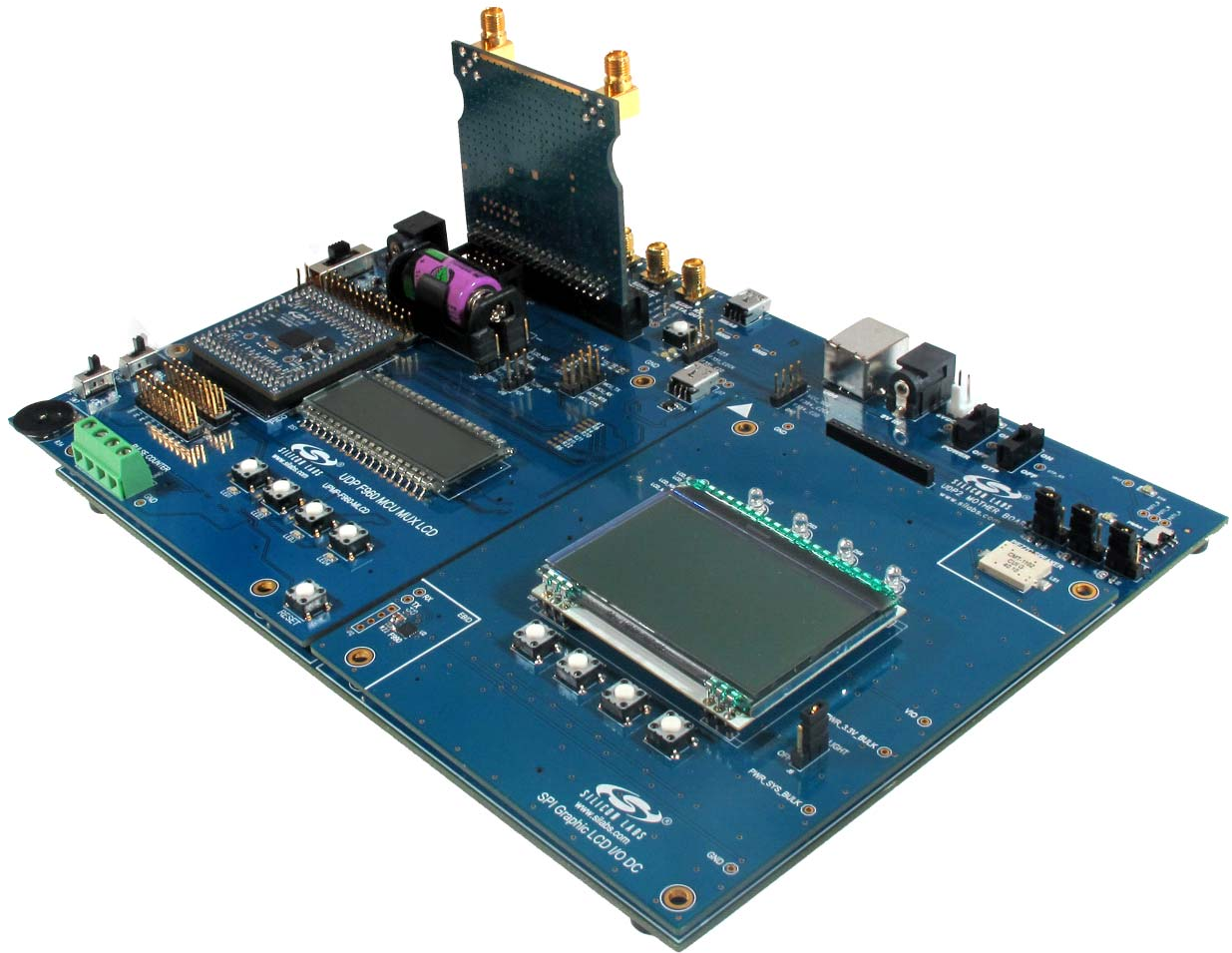

Figure 1. Unified Development Platform

# C8051F96x/Si102x

---

## 2. Relevant Documents

This document provides a hardware overview for the Unified Development Platform (UDP) system UDP C8051F960/Si1020 MCU Card with EMIF. Additional information on the UDP system can be found in the documents listed in this section.

### 2.1. Motherboard User's Guide

The UDP Motherboard User's Guide contains information on the motherboard features and can be found at [www.silabs.com](http://www.silabs.com).

### 2.2. Card User's Guides

The UDP MCU Card and Radio Card User's Guides can be found at [www.silabs.com](http://www.silabs.com).

## 3. Hardware Setup

### 3.1. Using the MCU Card Alone

Refer to Figure 2 for a diagram of the hardware configuration when using the MCU card without a UDP motherboard.

1. Connect the USB Debug Adapter to the 2x5 debug connector on the MCU card with the 10-pin ribbon cable.
2. Connect one end of the USB cable to the USB connector on the USB Debug Adapter.
3. Connect the other end of the USB cable to a USB Port on the PC.
4. Move the SW5 VBAT switch to the middle VREG position.
5. Move the SW7 VIO switch to the upper VBAT position.
6. Move the SW12 VIORF switch to the upper VBAT position.
7. Connect the 9 V DC adapter to P1.

#### Notes:

- Use the Reset button in the IDE to reset the target when connected using a USB Debug Adapter.
- Remove power from the MCU card and the USB Debug Adapter before connecting or disconnecting the ribbon cable from the MCU card. Connecting or disconnecting the cable when the devices have power can damage the device and/or the USB Debug Adapter.

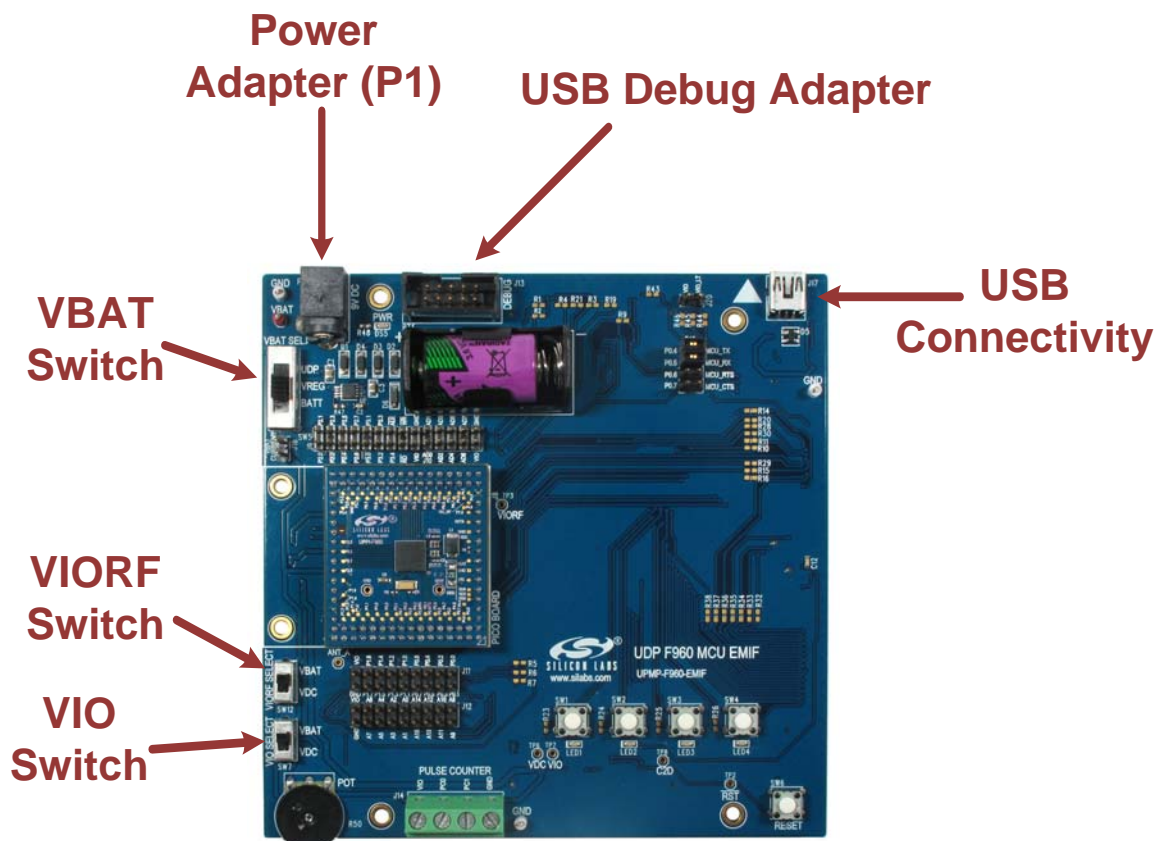

Figure 2. Hardware Setup Using the MCU Card Alone

# C8051F96x/Si102x

## 3.2. Using the MCU Card with the UDP Motherboard

Refer to Figure 3 for a diagram of the hardware configuration when using the MCU card with a UDP motherboard.

1. Connect the MCU card to the UDP motherboard slot.
2. (Optional) Connect the I/O card to the UDP motherboard slot.
3. (Optional) Connect a radio card to the radio card slot in the UDP motherboard.
4. (Optional) Connect an EZLink card to the EZLink card slot in the UDP motherboard.
5. Connect the USB Debug Adapter to the 2x5 debug connector on the MCU card with the 10-pin ribbon cable.
6. Connect one end of the USB cable to the USB connector on the USB Debug Adapter.
7. Connect the other end of the USB cable to a USB Port on the PC.
8. Connect the ac/dc power adapter to power jack J20 on the UDP motherboard. The board can also be powered from the J16 USB or J1 mini USB connectors.
9. Move the SW5 VBAT switch on the MCU card to the VREG position.
10. Move the SW7 VIO switch on the MCU card to the upper VBAT position.
11. Move the SW12 VIORF switch on the MCU card to the upper VBAT position.
12. Move the S3 power switch on the UDP motherboard to the ON position.

### Notes:

- Use the Reset button in the IDE to reset the target when connected using a USB Debug Adapter.
- Remove power from the target board and the USB Debug Adapter before connecting or disconnecting the ribbon cable from the target board. Connecting or disconnecting the cable when the devices have power can damage the device and/or the USB Debug Adapter.
- The MCU card can be used alone without the motherboard. However, the motherboard must be powered if an MCU card is connected.

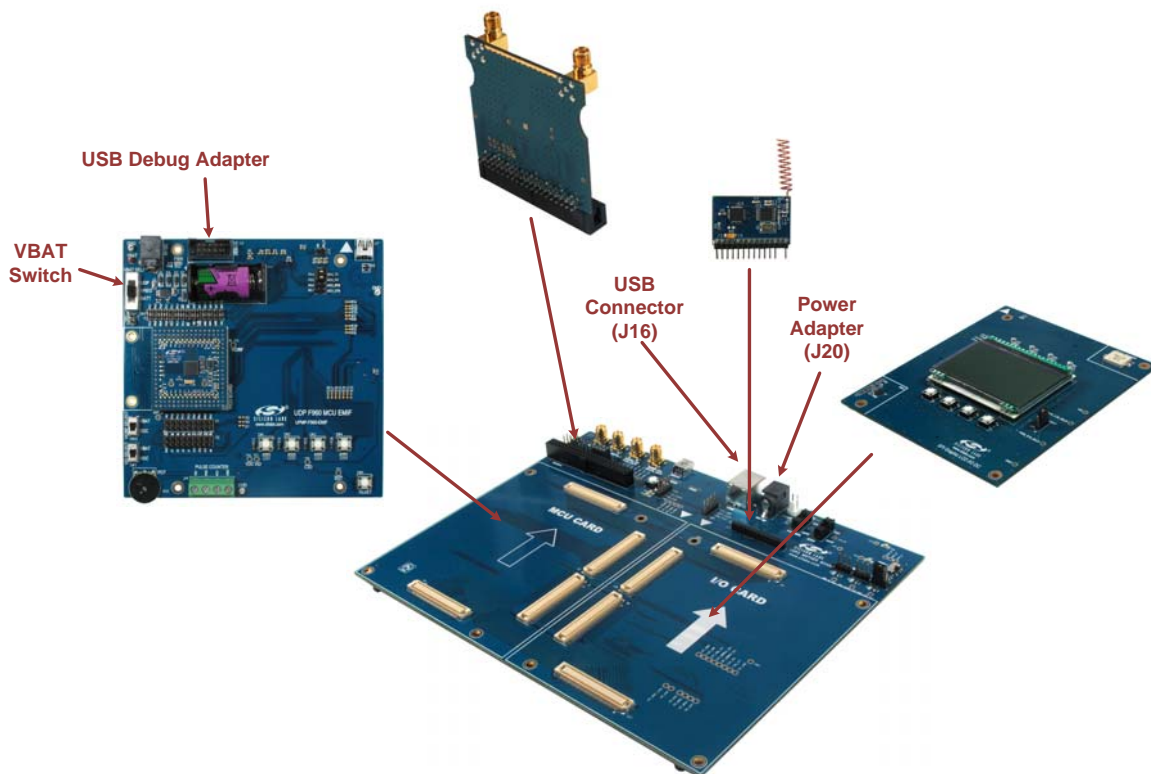
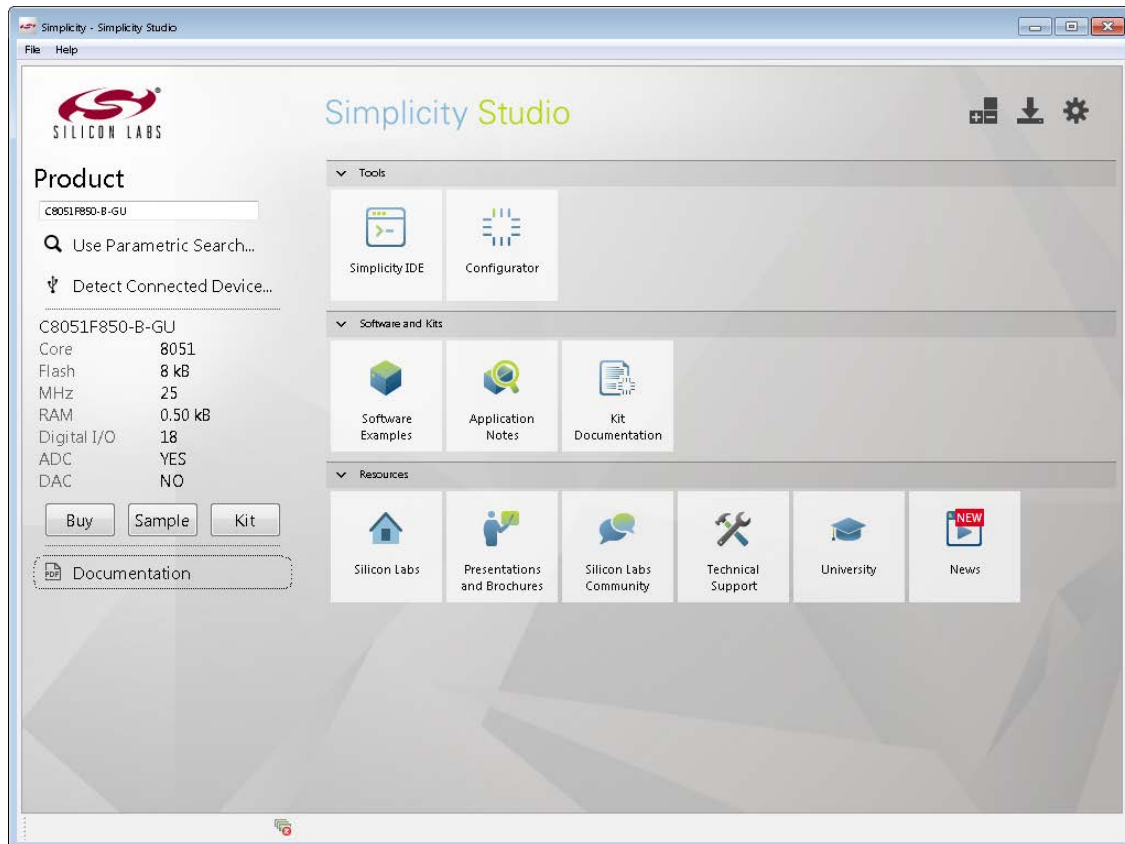

Figure 3. Hardware Setup Using the Unified Development Platform

## 4. Software Setup

Simplicity Studio greatly reduces development time and complexity with Silicon Labs EFM32 and 8051 MCU products by providing a high-powered IDE, tools for hardware configuration, and links to helpful resources, all in one place.

Once Simplicity Studio is installed, the application itself can be used to install additional software and documentation components to aid in the development and evaluation process.



**Figure 4. Simplicity Studio**

The following Simplicity Studio components are required for the C8051F960 Development Kit:

- 8051 Products Part Support
- Simplicity Developer Platform

Download and install Simplicity Studio from [www.silabs.com/8bit-software](http://www.silabs.com/8bit-software) or [www.silabs.com/simplicity-studio](http://www.silabs.com/simplicity-studio). Once installed, run Simplicity Studio by selecting **Start**→**Silicon Labs**→**Simplicity Studio**→**Simplicity Studio** from the start menu or clicking the **Simplicity Studio** shortcut on the desktop. Follow the instructions to install the software and click **Simplicity IDE** to launch the IDE.

The first time the project creation wizard runs, the **Setup Environment** wizard will guide the user through the process of configuring the build tools and SDK selection.

In the **Part Selection** step of the wizard, select from the list of installed parts only the parts to use during development. Choosing parts and families in this step affects the displayed or filtered parts in the later device selection menus. Choose the C8051F96x family by checking the **C8051F96x** check box. Modify the part selection at any time by accessing the **Part Management** dialog from the **Window**→**Preferences**→**Simplicity Studio**→**Part Management** menu item.

Simplicity Studio can detect if certain toolchains are not activated. If the **Licensing Helper** is displayed after completing the **Setup Environment** wizard, follow the instructions to activate the toolchain.

# C8051F96x/Si102x

---

## 4.1. Running Blinky

Each project has its own source files, target configuration, SDK configuration, and build configurations such as the **Debug** and **Release** build configurations. The IDE can be used to manage multiple projects in a collection called a workspace. Workspace settings are applied globally to all projects within the workspace. This can include settings such as key bindings, window preferences, and code style and formatting options. Project actions, such as build and debug are context sensitive. For example, the user must select a project in the **Project Explorer** view in order to build that project.

To create a project based on the Blinky example:

1. Click the **Simplicity IDE** tile from the Simplicity Studio home screen.
2. Click the **Create new project** link from the welcome screen or go to **File**→**New**→**Silicon Labs MCU Project**.
3. In the **Kit** drop-down, select **C8051F960 Development Kit**, in the **Part** drop-down, select **C8051F960**, and in the **SDK** drop-down, select the desired SDK. Click **Next**.
4. Select **Example** and click **Next**.
5. Under **C8051F960 Development Kit** in the **Blinky** folder, select **F96x Blinky** and click **Finish**.
6. Click on the project in the **Project Explorer** and click **Build**, the hammer icon in the top bar. Alternatively, go to **Project**→**Build Project**.
7. Click **Debug** to download the project to the hardware and start a debug session.
8. Press the **Resume** button to start the code running. The LED should blink.



9. Press the **Suspend** button to stop the code.



10. Press the **Reset the device** button to reset the target MCU.



11. Press the **Disconnect** button to return to the development perspective.



## 4.2. Simplicity Studio Help

Simplicity Studio includes detailed help information and device documentation within the tool. The help contains descriptions for each dialog window. To view the documentation for a dialog, click the question mark icon in the window:



This will open a pane specific to the dialog with additional details.

The documentation within the tool can also be viewed by going to **Help**→**Help Contents** or **Help**→**Search**.



## 4.3. Legacy 8-bit IDE

**Note:** Using the Simplicity Studio tools with the C8051F960 Development Kit is recommended. See section 4. "Software Setup," on page 5 for more information.

Download the 8-bit software from the website ([www.silabs.com/8bit-software](http://www.silabs.com/8bit-software)) or use the provided installer on the CD-ROM to install the software tools for the C8051F96x devices. After installation, examples can be found in ...\\Examples\\C8051F96x or ...\\Examples\\Si102x\_3x in the installation directory. At a minimum, the C8051F960 DK requires:

- **Silicon Labs IDE**—Software enabling initial evaluation, development, and debugging.
- **Configuration Wizard 2**—Initialization code generation software for the C8051F96x devices.
- **Keil C51 Tools**—Keil 8051 Compiler/Assembler/Linker toolchain.
- **CP210x Drivers**—Virtual COM Port (VCP) drivers for the CP210x COM interface. More information on this installation process can be found in Section Figure 3.

Other software available includes:

- **Keil  $\mu$ Vision Driver**—Driver for the Keil  $\mu$ Vision IDE that enables development and debugging on C8051Fxxx MCUs.
- **Flash Programming Utilities and MCU Production Programmer**—Programming utilities for the production line. More information on the available programming options can be found on the website: <http://www.silabs.com/products/mcu/Pages/ProgrammingOptions.aspx>.
- **ToolStick Development Tools**—Software and examples for the ToolStick development platform. More information on this platform can be found at [www.silabs.com/toolstick](http://www.silabs.com/toolstick).

Also available on the 8-bit software webpage is the Battery Life Estimator, which gives designers a quick and easy way to understand the discharge characteristics of different system configurations to help optimize low-power applications.

The development kit includes the latest version of the C51 Keil 8051 toolset. This toolset is initially limited to a code size of 2 kB and programs start at code address 0x0800. After registration, the code size limit is removed entirely and programs will start at code address 0x0000.

To register the Keil toolset:

1. Find the **Product Serial Number** printed on the CD-ROM. If you no longer have this serial number, register on the Silicon Labs website ([www.silabs.com/8bit-software](http://www.silabs.com/8bit-software)) to obtain the serial number.
2. Open the Keil  $\mu$ Vision4 IDE from the installation directory with administrative privileges.
3. Select **File**→**License Management** to open the License Management window.

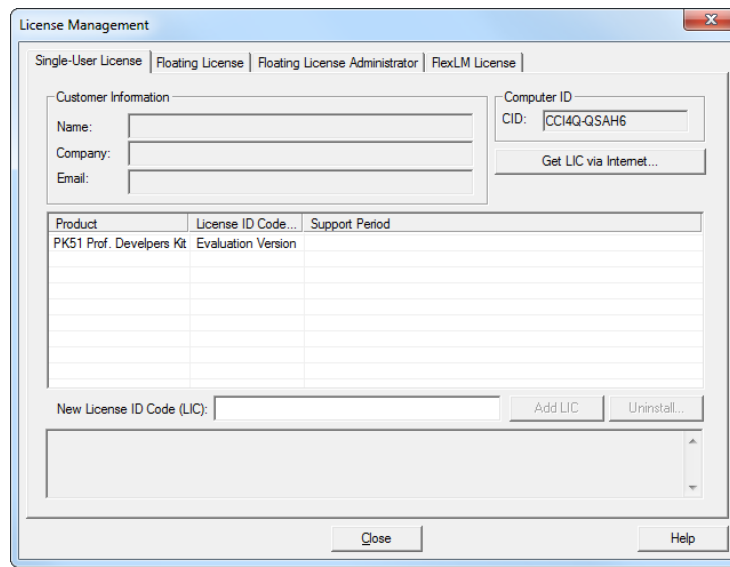

**Figure 5. Keil  $\mu$ Vision4 IDE License Management Window**

4. Click on the **Get LIC via Internet...** button to open the Obtaining a License IDE Code (LIC) window.
5. Press **OK** to open a browser window to the Keil website. If the window doesn't open, navigate to [www.keil.com/license/install.htm](http://www.keil.com/license/install.htm).
6. Enter the Silicon Labs **Product Serial Number** printed on the CD-ROM, along with any additional required information.
7. Once the form is complete, click the **Submit** button. An email will be sent to the provided email address with the license activation code.
8. Copy the License ID Code (LIC) from the email.
9. Paste the LIC into the **New License ID Code (LIC)** text box at the bottom of the License Management window in  $\mu$ Vision4.
10. Press the **Add LIC** button. The window should now list the **PK51 Prof. Developers Kit for Silabs** as a licensed product.
11. Click the **Close** button.

#### 4.4. CP210x USB to UART VCP Driver Installation

The MCU Card includes a Silicon Labs CP210x USB-to-UART Bridge Controller. Device drivers for the CP210x need to be installed before the PC software can communicate with the MCU through the UART interface. Use the drivers included CD-ROM or download the latest drivers from the website ([www.silabs.com/interface-software](http://www.silabs.com/interface-software)).

1. If using the CD-ROM, the **CP210x Drivers** option will launch the appropriate driver installer. If downloading the driver package from the website, unzip the files to a location and run the appropriate installer for the system (x86 or x64).
2. Accept the license agreement and follow the steps to install the driver on the system. The installer will let you know when your system is up to date. The driver files included in this installation have been certified by Microsoft.
3. To complete the installation process, connect the included USB cable between the host computer and the **COM PORT** USB connector (J5) on the MCU Card. Windows will automatically finish the driver installation. Information windows will pop up from the taskbar to show the installation progress.
4. If needed, the driver files can be uninstalled by selecting **Windows Driver Package—Silicon Laboratories...** option in the **Programs and Features** window.



## 4.5. Silicon Labs Battery Life Estimator

The Battery Life Estimator is a system design tool for battery operated devices. It allows the user to select the type of battery they are using in the system and enter the supply current profile of their application. Using this information, it performs a simulation and provides an estimated system operating time. The Battery Life Estimator is shown in Figure 6.

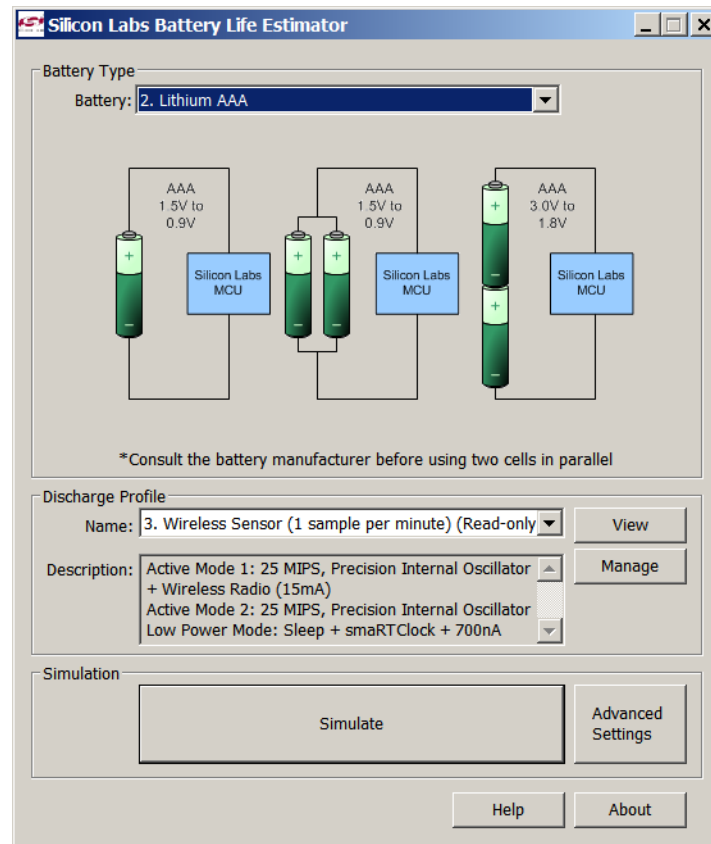

**Figure 6. Battery Life Estimator Utility**

From Figure 6, the two inputs to the Battery Life Estimator are battery type and discharge profile. The utility includes battery profiles for common battery types such as AAA, AA, A76 Button Cell, and CR2032 coin cell. The discharge profile is application-specific and describes the supply current requirements of the system under various supply voltages and battery configurations. The discharge profile is independent of the selected power source. Several read-only discharge profiles for common applications are included in the pulldown menu. The user may also create a new profile for their own applications.

To create a new profile:

1. Select the profile that most closely matches the target application or choose the "Custom Profile".
2. Click Manage.
3. Click Duplicate.
4. Click Edit.

Profiles may be edited with the easy-to-use GUI (shown in Figure 7).

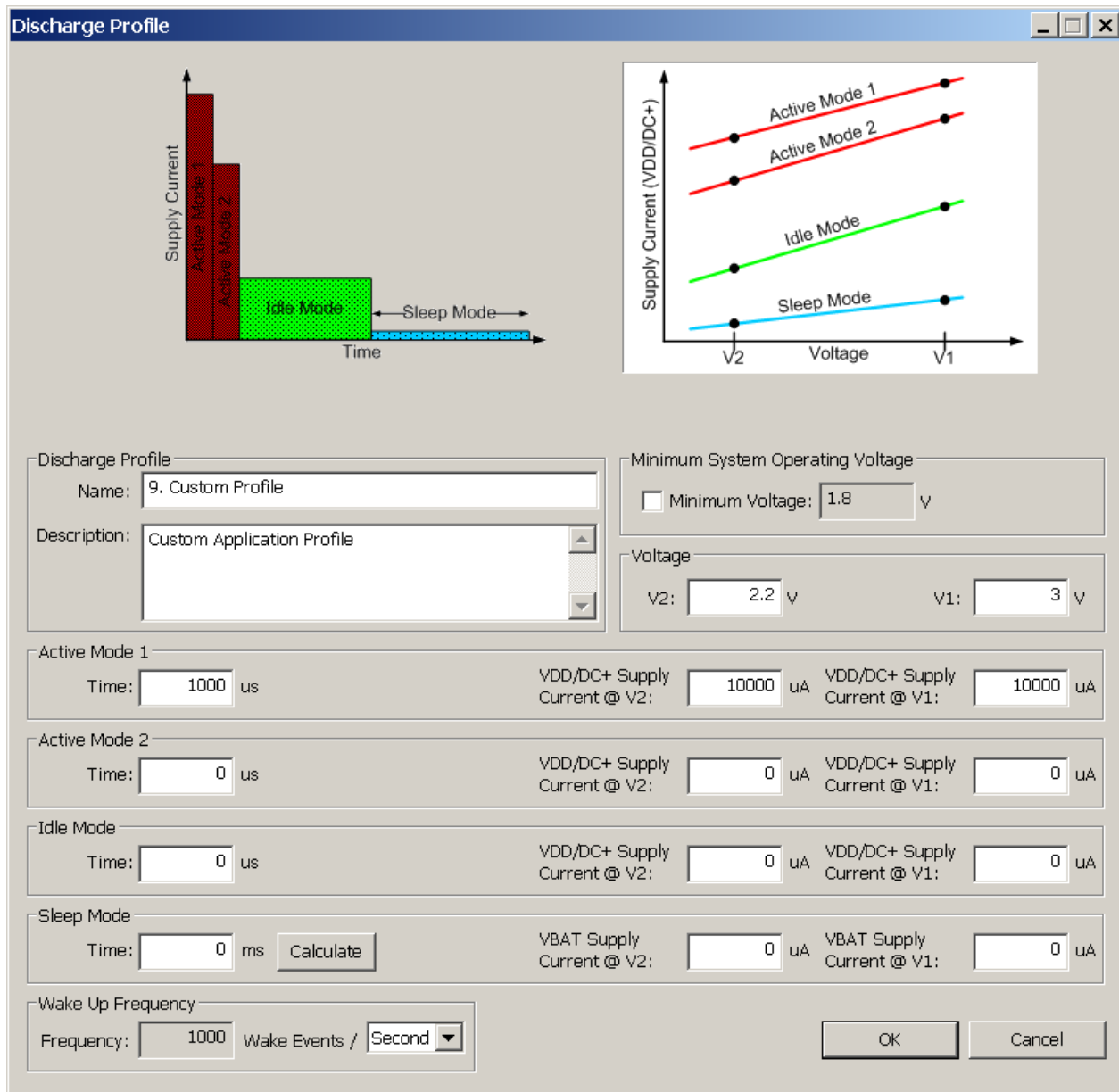

**Figure 7. Battery Life Estimator Discharge Profile Editor**

The Discharge Profile Editor allows the user to modify the profile name and description. The four text entry boxes on the left hand side of the form allow the user to specify the amount of time the system spends in each power mode. On the right hand side, the user may specify the supply current of the system in each power mode.

Since supply current is typically dependent on supply voltage, the discharge profile editor provides two columns for supply current. The V2 and V1 voltages at the top of the two columns specify the voltages at which the current measurements were taken. The Battery Life Estimator creates a linear approximation based on the input data and is able to feed the simulation engine with an approximate supply current demand for every input voltage.

The minimum system operating voltage input field allows the system operating time to stop increasing when the simulated battery voltage drops below a certain threshold. This is primarily to allow operating time estimates for systems that cannot operate down to 1.8 V, which is the voltage of two fully drained single-cell batteries placed in series.

The wakeup frequency box calculates the period of a single iteration through the four power modes and displays the system wake up frequency. This is typically the "sample rate" in low power analog sensors.

Once the battery type and discharge profile is specified, the user can click the "Simulate" button to start a new simulation. The simulation engine calculates the estimated battery life when using one single-cell battery, two single-cell batteries in series, and two single-cell batteries in parallel. Figure 8 shows the simulation output window.

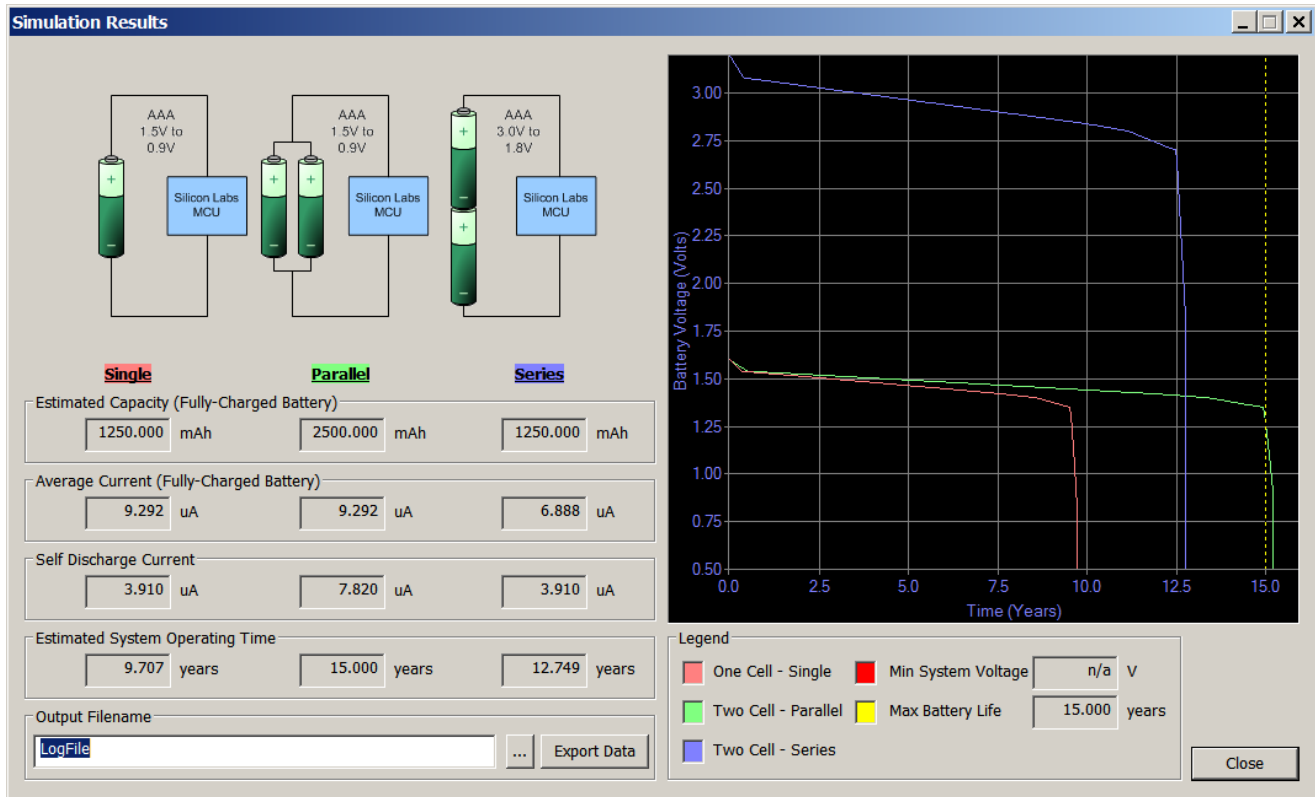

**Figure 8. Battery Life Estimator Utility Simulation Results Form**

The primary outputs of the Battery Life Estimator are an estimated system operating time and a simulated graph of battery voltage vs. time. Additional outputs include estimated battery capacity, average current, self-discharge current, and the ability to export graph data to a comma delimited text file for plotting in an external graphing application.

# C8051F96x/Si102x

## 5. UDP C8051F960/Si1020 MCU Card with EMIF Overview

The C8051F96x MCU card enables application development on the C8051F960 MCU. The card connects to the MCU Card expansion slot on the UDP motherboard and provides complete access to the MCU resources. Each expansion board has a unique ID that can be read out of an EEPROM or MCU on the board, which enables software tools to recognize the connected hardware and automatically select the appropriate firmware image. The target MCU card can also be detached from the UDP and used alone as a development or demonstration tool.

Figure 9 shows the C8051F96x MCU card.

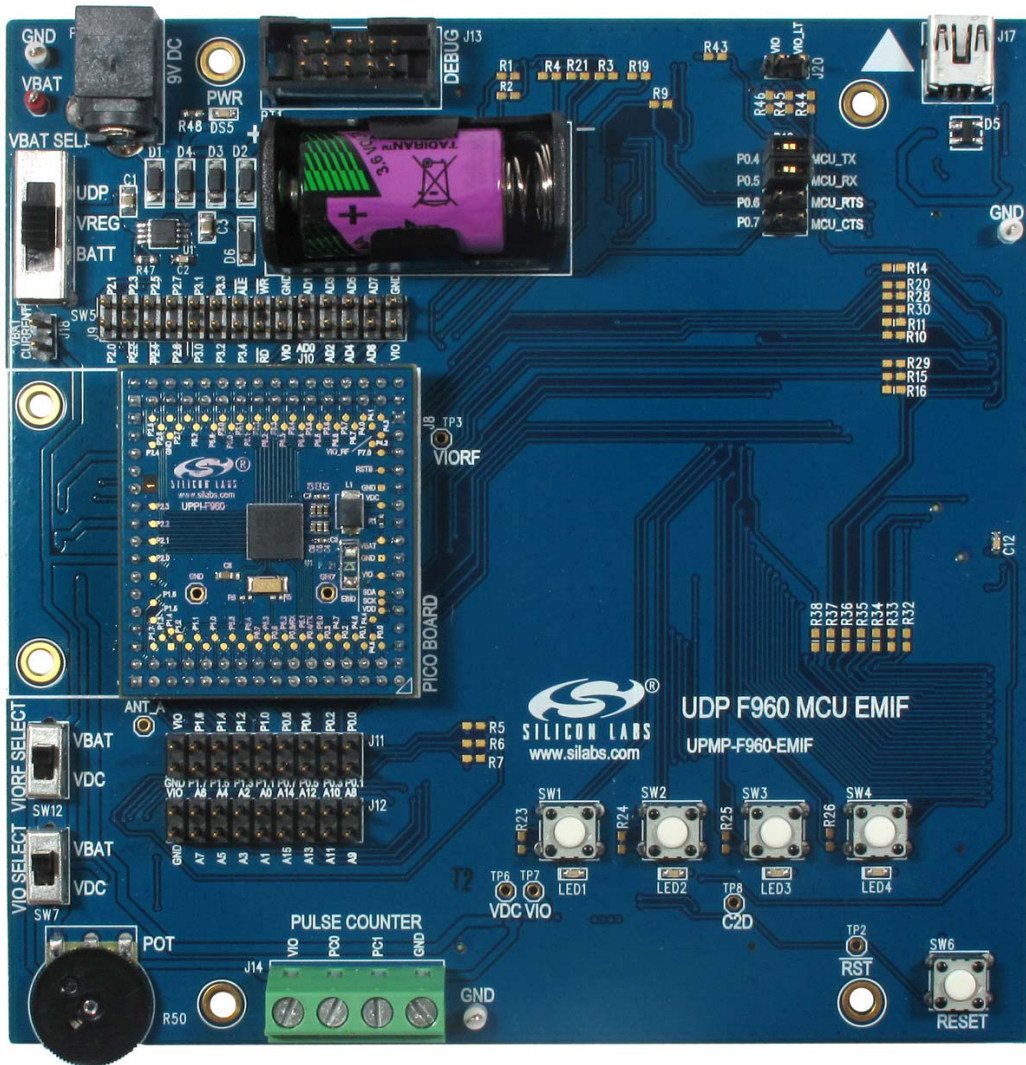

Figure 9. C8051F96x UDP MCU Card

Figure 10 highlights some of the features of the UDP C8051F960/Si1020 MCU Card with EMIF.

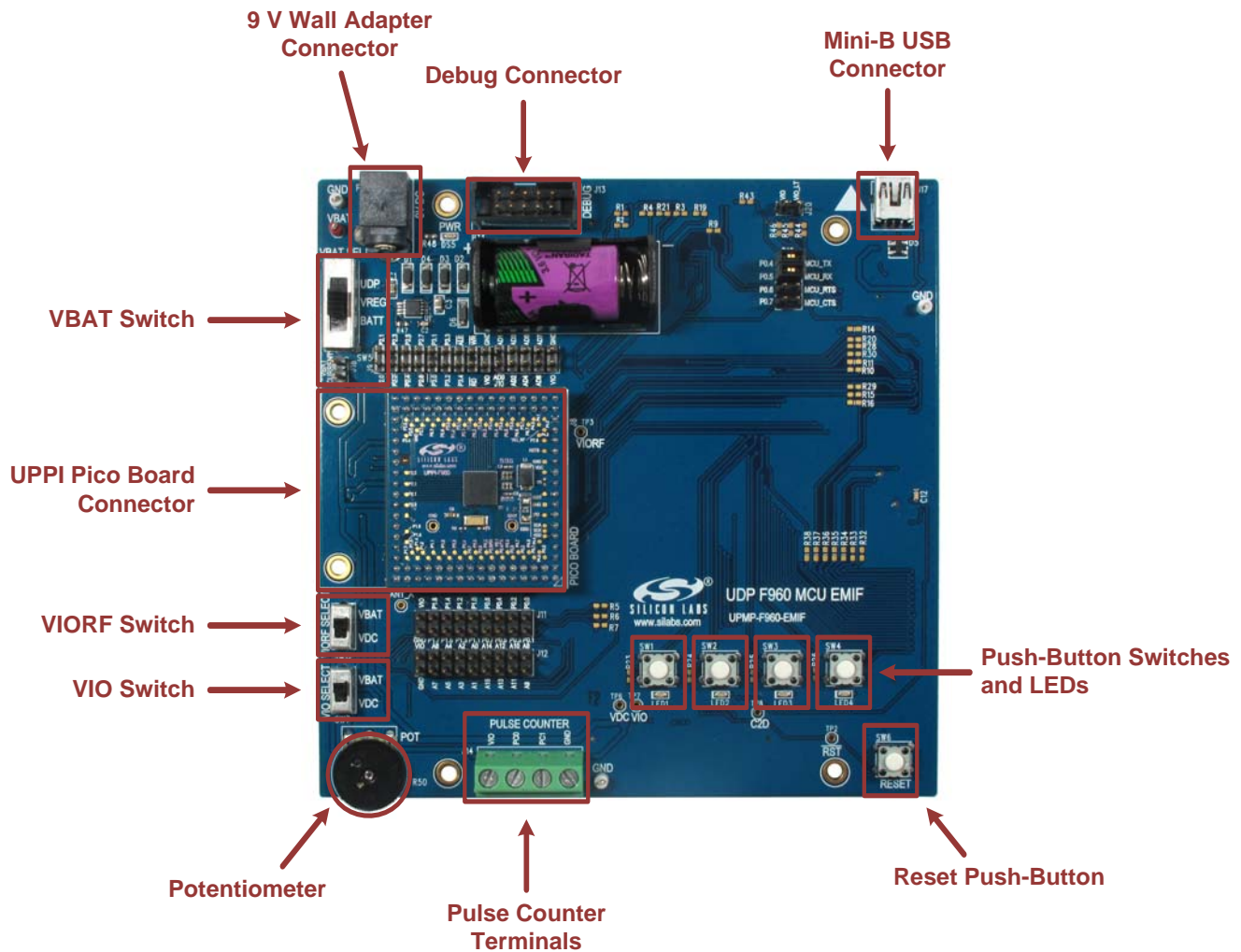

Figure 10. UDP C8051F960/Si1020 MCU Card with EMIF

## 5.1. UPPI Pico Board Connector (J5, J6, J7, J8)

The UPPI Pico Board connector accommodates a variety of C8051F96x and Si102x/3x UPPI Pico Boards. The C8051F960 MCU and Si1020 Wireless MCU UPPI Pico Boards share a common form factor. This enables the MCU card to support a wide variety of wired and wireless applications.

The supported UPPI Pico Boards include:

- UPPI-F960
- UPPI-Si1020GMxxxTR

The Si1020/30 UPPI Pico Boards include an EZRadioPRO<sup>®</sup> transceiver. The C8051F960 UPPI Pico Boards do not include an RF transceiver; instead, these boards support most Silicon Labs 40-pin radio test cards when used with the Unified Development Platform Motherboard.



## 5.2. Push-Button Switches and LEDs (SW1–SW4, LED1–LED4)

The UDP C8051F960/Si1020 MCU Card with EMIF has four push-button switches. The four switches connect to P3.0 through P3.3. The switches are normally open and pull the pin voltage to ground when pressed.

Port pins P3.0 through P3.3 also connect to four LEDs: LED1 through LED4. The LEDs connect to VIO through a current limiting resistor.

This multiplexing arrangement reduces the number of port pins used from eight to four. Firmware may easily use either the LED or the switch for each port pin. When using both the LED and the switch on the same port pin, firmware must momentarily toggle off the LED by writing a 1 to the pin's port latch to read the push-button switch status.

## 5.3. VBAT Selection Switch (SW5)

The UDP C8051F960/Si1020 MCU Card with EMIF has many power options. The VBAT selector switch (SW5) selects the power source for the main C8051F960/Si1020 VBAT supply pin.

The center VREG position selects the output of the on-board 3.3 V regulator (U1). This is the primary supply option for development. The on-board regulator has multiple 5 V and 9 V power sources connected via Schottky diodes to the regulator input. The highest voltage power source will supply power to the regulator.

The power sources for the on-board regulator (U1) are as follows:

- 9 V DC Wall Adapter power receptacle (P1).
- Mini-B USB receptacle (J17).
- 10-pin Debug connector (J13).
- UDP motherboard +5 V (when connected).

The BATT position selects the ultra long life 3.6 V lithium thionyl chloride battery (BT1). This battery is a typical power source for metering applications. The on-board regulator should be used primarily for development because the battery has a limited peak current capacity.

The UDP position on the VBAT selector selects the UDP motherboard programmable supply (PWR\_VDD\_OUT) as the power source for the UPPI Pico Board. Use this position when using the programmable power supply under software control.

The UDP motherboard can also provide power to the on-board regulator. The VREG position will always work with the motherboard, while the UDP switch position requires some motherboard configuration. The UDP motherboard User's Guide contains additional information.

The VBAT voltage and ground are available on test points in the top-left corner of the MCU card. Use these test points to power the board from an external lab power supply. When using a lab supply, the VBAT selector switch should be in the BATT position with the battery removed.

## 5.4. Debug Header (J13)

The standard 10-pin debug header supports the Silicon Labs USB Debug Adapter. This connector provides a C2 debug connection to C8051F960/Si1020 on the UPPI Pico Board. The USB Debug Adapter supports two types of debug connections: C2 and JTAG. When using this MCU card with the Silicon Labs IDE, select C2 in the connection options dialog before connecting.

The USB Debug Adapter also provides a 5 V power source that can power the regulator. When powering the MCU from the debug connector, the VBAT switch must be in the VREG position. Additionally, select the Power Target after Disconnect check box in the Silicon Labs IDE connections options dialog to ensure the MCU always has power.

## 5.5. Reset Button (SW6)

The reset push-button switch is in the lower-right corner. Pushing this button will always reset the MCU. Note that pushing this button while the IDE is connected to the MCU will result in the IDE disconnecting from the target.



## 5.6. Pin Power Supply Select Switches

The C8051F960/Si1020 MCU has two VIO pins: VIO and VIORF. These VIO pins set the logic level and drive voltage for the MCU port pins. The VIORF pin sets the level for the port pins normally supporting radio functionality: P1.5 through P2.3. The Si1020 P2.0-2.3 pins are connected internally to the EZRadioPRO. The VIO pin sets the level for all other port pins.

### 5.6.1. VIORF Select Switch (SW12)

When using the dc-dc buck converter to power the radio, set the VIORF selector switch to the VDC position. This connects the output of the buck converter to the VIORF pin. When using the Si1020, this switch also selects the power source for the radio. In this position, firmware controls the voltage on the VDC pin. The C8051F960/Si1020 buck converter also has a bypass switch that can power the radio from the full supply voltage. The dc-dc buck converter and bypass switch are off by default after an MCU reset, so the VDC pin voltage is floating until firmware turns on the bypass switch or configures the dc-dc converter.

When the VIORF selector switch is set to the VBAT position, the VIORF pin connects via hardware to the VBAT pin. In this position, the dc-dc buck converter cannot power the radio.

The VBAT position powers the VIORF pin without any firmware. This position is more convenient for simple code examples. Use this position for the code examples provided unless otherwise indicated.

### 5.6.2. VIO Select Switch (SW7)

The VIO selector switch provides the same functionality as the VIORF switch for the main VIO pin. Normally this switch should be in the VBAT position, which will set the drive and input levels of the pins to VBAT.

Setting the switch to the VDC position connects the VIO pin to the output of the buck converter. In this position, the battery powers the MCU, and all of the I/O ports operate at a lower voltage set by the buck converter. This option is best if most of the I/O pins connect to a low voltage radio or other low-voltage peripherals. Most applications should use the VBAT position.

The C2 connection requires a VIO power source and VDC is not powered by default, so the VBAT position must be used for initial development.

## 5.7. UART VCP Connection Options

The MCU card features a USB virtual COM port (VCP) UART connection via the mini-B USB connector (J17). The VCP connection uses the CP2102 USB-to-UART bridge chip.

The UART pins on the target MCU either connect to the CP2102 USB-to-UART bridge chip or to the UDP motherboard. The MCU card has level translators with enables that normally route the UART connections to the on-board USB-to-UART bridge chip. However, the UDP motherboard can drive the enable pins to route the UART connections to the UDP motherboard instead of the on-board USB-to-UART bridge chip. There are two enable signals: one with a default pull-down (UART\_VCP\_EN) and one with a default pull-up (UART\_SYS\_EN).

When using the UART with either the on-board USB-to-UART bridge or the UDP motherboard, install shorting blocks on header P12 to connect P0.4 to MCU\_TX and P0.5 to MCU\_RX.

If desired, install shorting blocks for hardware handshaking on P0.6 and P0.7 on the P12 header. Hardware handshaking is not required for most applications. Firmware must implement hardware handshaking on the target MCU using P0.6 and P0.7. These pins also connect to the 40-pin radio card I2C signals by default. If necessary, disconnect these signals by cutting the traces on R9 and R10.

The MCU card includes provisions to facilitate ultra-low power measurements. The UART pins of the target MCU are completely disconnected from the USB-to-UART bridge by removing all the shorting blocks on P12. The VIO supply powers the level translator. To remove the level-shifter current from the ultra-low power measurement, cut the trace on the bottom of the board between the two pins of header J20. This will completely disconnect the level translators from VIO. After cutting this trace, a shorting block is required on J20 to use the USB-to-UART bridge or UDP UART connection.

# C8051F96x/Si102x

---

## 5.8. Potentiometer (R50)

The potentiometer is available on P1.4. To facilitate a low-power potentiometer, P2.7 connects to bottom of the potentiometer as a potentiometer enable (POT\_EN). Drive P2.7 low to enable the potentiometer. Alternatively, install a 0  $\Omega$  resistor for R51 to continuously enable the potentiometer.

## 5.9. Pulse Counter Terminals (J14)

The MCU card includes a 4-position screw terminal connection. These field-wiring terminals will accept large wire for a commercial water or gas meter. The PC0 and PC1 signals connect to P1.0 and P1.1 on the target MCU. These are dedicated pins for the C8051F960/Si1020 low-power pulse counter. The VIO and ground connections are also available for Form C meters. Refer to the C8051F960 data sheet for additional information about the pulse counter.

## 5.10. Port Pin Headers (J9-J12)

All of the MCU port pins are available on the 0.100 inch headers on either side of the UPPI Pico Board.

Pins P1.2 and P1.3 are normally used for the RTC and are not connected by default to the P1.2 and P1.3 headers. To use P1.2 and P1.3 for other purposes, remove the RTC crystal on the UPPI Pico Board and populate the two small adjacent resistors with 0  $\Omega$  resistors.

When using the Si1020 UPPI Pico Board, the SPI1 pins are connected internally and do not connect to the header pins.

## 5.11. C8051F96x Board Default and Optional Connections

The C8051F96x MCU card has many default and optional connections for use with different radios and the UDP motherboard. The default connections have shorting jumpers consisting of a 603 resistor footprint with a trace between the pads. To disconnect a default connection, cut the trace between the pads. To reconnect, install a 0  $\Omega$  603 resistor or connect the two pads with solder. The optional connections are non-populated (no-pop) resistor footprints. To connect, install a 0  $\Omega$  603 resistor or connect the two pads with solder.

When using the Si1020 UPPI Pico Board, some of the MCU port pins connect to EZRadioPRO port pins by default. Note that plugging the UPPI Pico Board into the MCU card will connect some pins together.

Table 1 shows a summary of the default and optional connections for each pin.

**Table 1. MCU Pin Functions**

MCU Pin	MCU Card Function		UDP Motherboard Signal	
	Default	Optional	Default	Optional
P0.0			SPI_LCD_SCK	EBID_SCK
P0.1			SPI_LCD_MISO	EBID_MISO
P0.2			SPI_LCD_MOSI	EBID_MOSI
P0.3		VREF	SPI_LCD_NSS	
P0.4/TX	TX			
P0.5/RX	RX			
P0.6		CTS	EZR_I2C_SDA	
P0.7		RTS	EZR_I2C_SCL	GPIO2
P1.0	PC0			
P1.1	PC1			
P1.2	XTAL3			
P1.3	XTAL4			
P1.4	POT			EZR_ARSSI
P1.5	GPIO_1		EZRP_RX_DOUT/ EZRP_GPIO_1	EZR_FFIT
P1.6			EZRP_NIRQ	
P1.7			EZRP_SDN	
P2.0/SCK1			EZRP_SCK	
P2.1/MISO1			EZRP_MISO	
P2.2/MOSI1			EZRP_MOSI	
P2.3/NSS1			EZRP_NSS	
P2.4			PIEZO	
P2.5	GPIO_0		EZRP_TX_DATA_IN/ EZRP_GPIO_0	
P2.6			SPI_LCD_A0	
P2.7	POT_EN			
P3.0	SW1/LED1			
P3.1	SW2/LED2			

# C8051F96x/Si102x

Table 1. MCU Pin Functions (Continued)

MCU Pin	MCU Card Function		UDP Motherboard Signal	
	Default	Optional	Default	Optional
P3.2	SW3/LED3			
P3.3	SW4/LED4			
P3.4			RF_EBIF_NSS	
P4.6	ANT_A		EZR_CLKIN/ EZRP2_GPIO3	
P4.7	GPIO2		EZRP_RX_CLKOUT/ EZRP_GPIO2	

## 5.11.1. P0.0 through P0.3

Pins P0.0 through P0.3 connect to the UDP SPI\_LCD signals (SPI\_LCD\_SCK, SPI\_LCD\_MISO, SPI\_LCD\_MOSI, SPI\_LCD\_NSS) by default. These signals support the optional Graphical LCD display I/O card when used with the UDP motherboard. To disconnect these default connections, cut the traces on R1 through R4. Optionally, these signals can also connect to the EBID SPI on the 40-pin radio card. R8 provides an option to use P0.0 as a voltage reference.

## 5.11.2. P0.6

Pin P0.6 connects to EZRP\_I2C\_SDA by default. This signal supports I2C radios and EZRadio transceivers using the 40-pin radio connector on the UDP motherboard.

## 5.11.3. P0.7

Pin P0.7 connects to EZRP\_I2C\_SCL by default. This signal supports I2C radios using the 40-pin radio connector on the UDP motherboard. The MCU card provides optional connections to connect P0.7 to EZRP\_RX\_CLKOUT or use P0.7 as the IREF current reference pin.

## 5.11.4. P1.4

Pin P1.4 normally connects to the potentiometer. Optionally, P1.4 can connect to EZR\_ARSSI. This signal supports an analog RSSI measurement using an EZRadio 40-pin test card.

## 5.11.5. P1.5

Pin P1.5 connects to GPIO\_1 via R15 and R29 by default. To disconnect this signal, cut the trace on R15. This signal supports the clear-to-send (CTS) signal for EZRadioPRO.

## 5.11.6. P1.6

Pin P1.6 normally connects to nIRQ using R17. Cut the trace on R17 to disconnect these signals. Note that P1.7 also connects to nIRQ on the UPPI Pico Board, so a trace on the UPPI Pico Board must also be cut.

## 5.11.7. P1.7

Pin P1.7 connects to SDN via R18. To disconnect these signals, cut the trace on R18. P1.7 also connects to SDN on the UPPI Pico Board, so it is necessary to also cut a trace on the UPPI Pico Board.

## 5.11.8. P2.4

P2.4 normally connects to the PIEZO signal. This signal drives a piezo transducer on the graphical LCD I/O card.

## 5.11.9. P2.5

Pin P2.5 connects to the GPIO\_0 via R20 and R28 by default. Cut the trace on R20 to disconnect these signals. This signal supports direct mode communication with the Si1020 EZRadio.

## 5.11.10. P3.6

P3.6 normally connects to SPI\_LCD\_A0. This signal supports the Graphical LCD display I/O card.

## 5.11.11. EZRadio GPIO Signals

When using a Si1020 UPPI Pico Board, the four EZRadioPRO GPIO signals connect to the SMA connectors on the motherboard.

GPIO\_0 connects to EZRP\_TX\_DATA\_IN via R20. This signal supports direct mode TX input data from an external source using the SMA connector.

GPIO\_1 connects to EZRP\_RX\_DOUT via R21. This signal supports direct mode RX data out of the SMA connector. Normally, the RX data out is used with the RX clock out.

GPIO\_2 connects to EZRP\_RX\_CLK\_OUT via R22. This signal supports direct mode RX data out of the SMA connector.

ANT\_A connects to EZR\_CLK\_IN using R23. This provides a connection to the forth SMA connector. Cut the trace on R23 when using an external 10 MHz clock with EZRadio.

## 5.11.12. EMIF Connections

Some of the EMIF lines also connect to the 40-pin radio card connector. EMIF\_A15/- connects to GPIO\_2, and EMIF\_A14/- connects to GPIO\_3. Disconnect these signals when using the EMIF in 16-bit address non-multiplexed mode.

Table 2 describes the C8051F96x MCU card's EMIF connections.

**Table 2. MCU EMIF Connections**

MCU Pin	EMIF Configurations				MCU Card Signal Name	UDP Motherboard Signal Name
	Non-Multiplexed		Multiplexed			
	16-bit	8-bit	16-bit	8-bit		
P3.5			ALE	ALE	EMIF_ALE	EMIF_ALE
P3.6	/RD	/RD	/RD	/RD	EMIF_RD	EMIF_OEB
P3.7	/WR	/WR	/WR	/WR	EMIF_WR	EMIF_WRB
P4.0	A8				EMIF_A8/-	EMIF_A16
P4.1	A9				EMIF_A9/-	EMIF_A17
P4.2	A10				EMIF_A10/-	EMIF_A18
P4.3	A11				EMIF_A11/-	EMIF_A19
P4.4	A12				EMIF_A12/-	EMIF_A20
P4.5	A13				EMIF_A13/-	EMIF_A21
P4.6	A14				EMIF_A14/-	EMIF_A22
P4.7	A15				EMIF_A15/-	EMIF_A23
P5.0	A0	A0	A8		EMIF_A0/A8/-	EMIF_A8
P5.1	A1	A1	A9		EMIF_A1/A9/-	EMIF_A9
P5.2	A2	A2	A10		EMIF_A2/A10/-	EMIF_A10
P5.3	A3	A3	A11		EMIF_A3/A11/-	EMIF_A11
P5.4	A4	A4	A12		EMIF_A4/A12/-	EMIF_A12
P5.5	A5	A5	A13		EMIF_A5/A13/-	EMIF_A13
P5.6	A6	A6	A14		EMIF_A6/A14/-	EMIF_A14
P5.7	A7	A7	A15		EMIF_A7/A15/-	EMIF_A15
P6.0	D0	D0	AD0	AD0	EMIF_D0/AD0	EMIF_A0
P6.1	D1	D1	AD1	AD1	EMIF_D1/AD1	EMIF_A1
P6.2	D2	D2	AD2	AD2	EMIF_D2/AD1	EMIF_A2

Table 2. MCU EMIF Connections (Continued)

MCU Pin	EMIF Configurations				MCU Card Signal Name	UDP Motherboard Signal Name
	Non-Multiplexed		Multiplexed			
	16-bit	8-bit	16-bit	8-bit		
P6.3	D3	D3	AD3	AD3	EMIF_D3/AD3	EMIF_A3
P6.4	D4	D4	AD4	AD4	EMIF_D4/AD4	EMIF_A4
P6.5	D5	D5	AD5	AD5	EMIF_D5/AD5	EMIF_A5
P6.6	D6	D6	AD6	AD6	EMIF_D6/AD6	EMIF_A6
P6.7	D7	D7	AD7	AD7	EMIF_D7/AD7	EMIF_A7



## 6. Using the C8051F96x with the UDP Motherboard

### 6.1. VBAT Selector Switch

When used with the UDP motherboard, the motherboard can power the C8051F96x MCU card. With the VBAT selector switch in the VREG position, the motherboard powers the regulator on the card. With the VBAT selector switch in the UDP position, the UDP motherboard powers VBAT directly. This position supports software control of the variable voltage power supply and current measurements.

The S1 switch on the UDP motherboard selects between the fixed or programmable voltage. The variable supply is controlled by the C8051F384 board control MCU through the U1 digital potentiometer. Use the fixed supply when the variable supply is not under software control.

### 6.2. MCU Card Header Connections

The C8051F96x MCU card has four connectors with 100 pins each. These 400 pins are directly tied to the UDP motherboard and I/O cards. These signals are named and designed to support a wide variety of features and applications, and the UDP C8051F960/Si1020 MCU Card with EMIF card implements a subset of these connections.

The MCU cards and I/O cards are designed so that a maximum number of functions are shared between each card. This allows a particular type of I/O card to be shared amongst all MCU cards that connect to the same signals.

The MCU card slot includes the following components:

- J1 MCU card connector H1
- J2 MCU card connector H2
- J3 MCU card connector H3
- J4 MCU card connector H4

The C8051F96x MCU card implements the signals described in Table 4, Table 5, Table 6, and Table 7 in the Appendix.

# C8051F96x/Si102x

## 6.3. Shorting Blocks: Factory Defaults

The UDP C8051F960/Si1020 MCU Card with EMIF comes from the factory with pre-installed shorting blocks on several headers. Figure 11 shows the positions of the factory default shorting blocks.

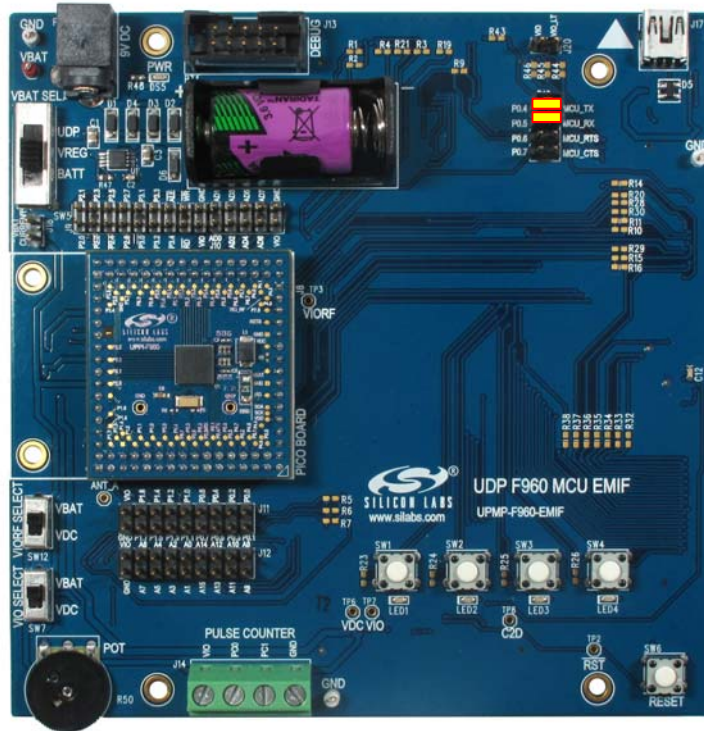

**Figure 11. Shorting Blocks: Factory Defaults**

Shorting blocks are installed on P2 to connect P0.4 to MCU\_TX and P0.5 to MCU\_RX.



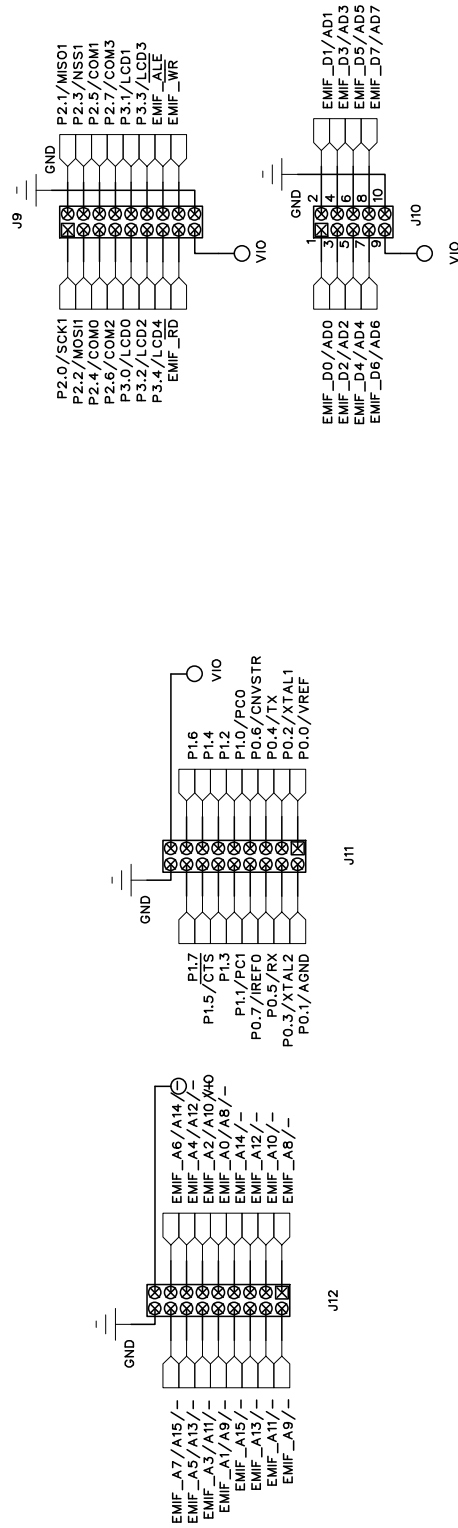

Figure 13. C8051F96x UDP MCU Card Schematic (2 of 6)

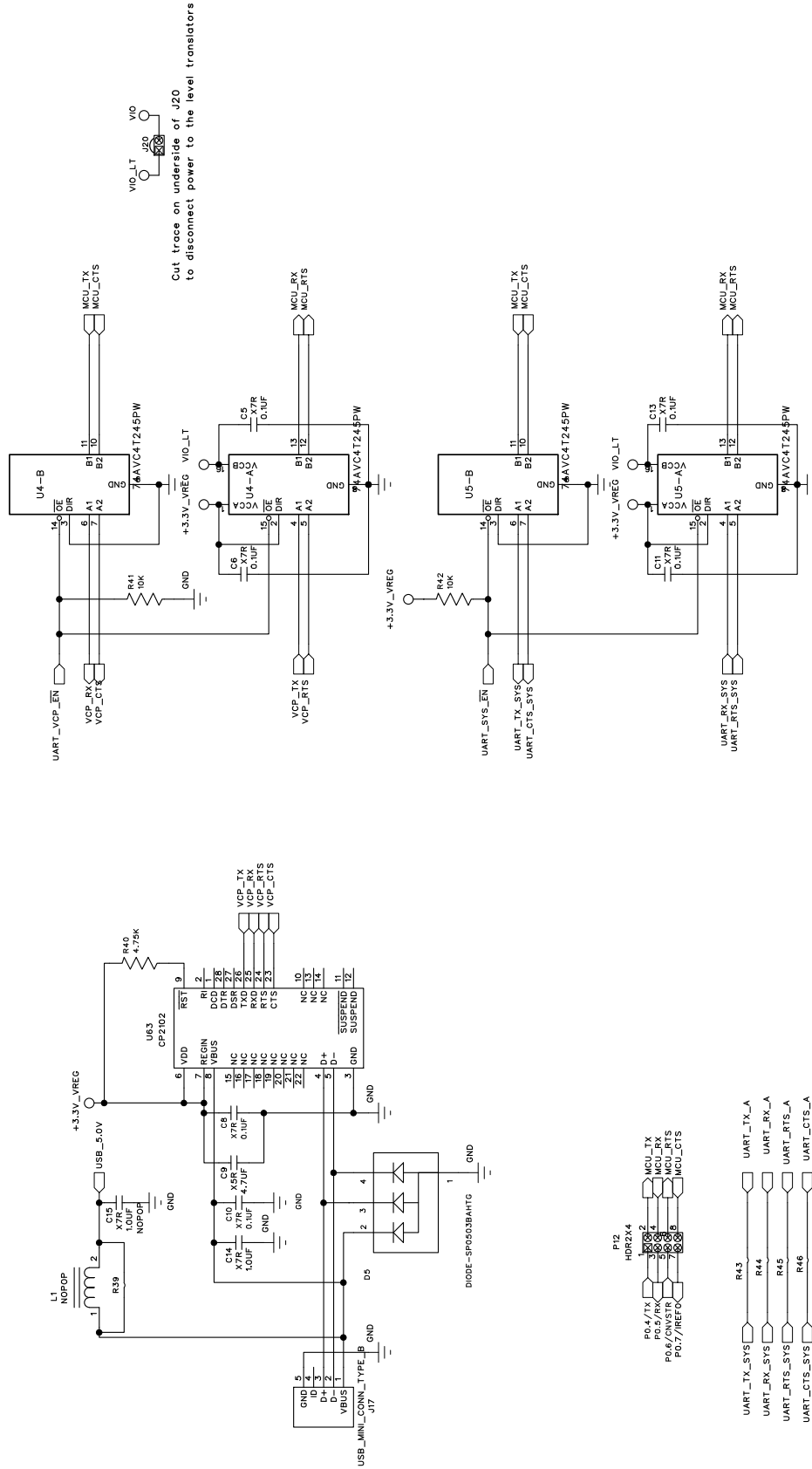

Figure 14. C8051F96x UDP MCU Card Schematic (3 of 6)

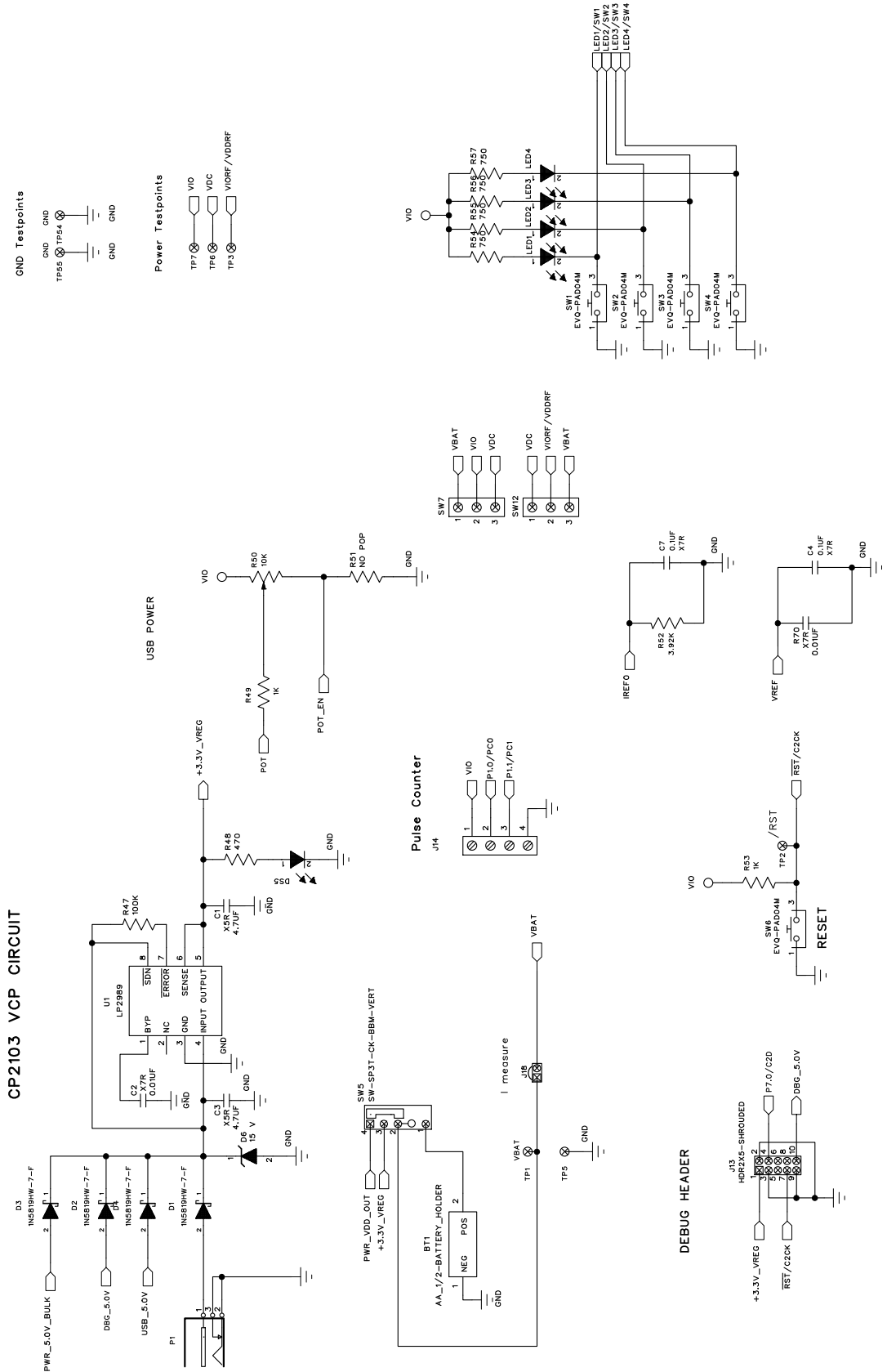
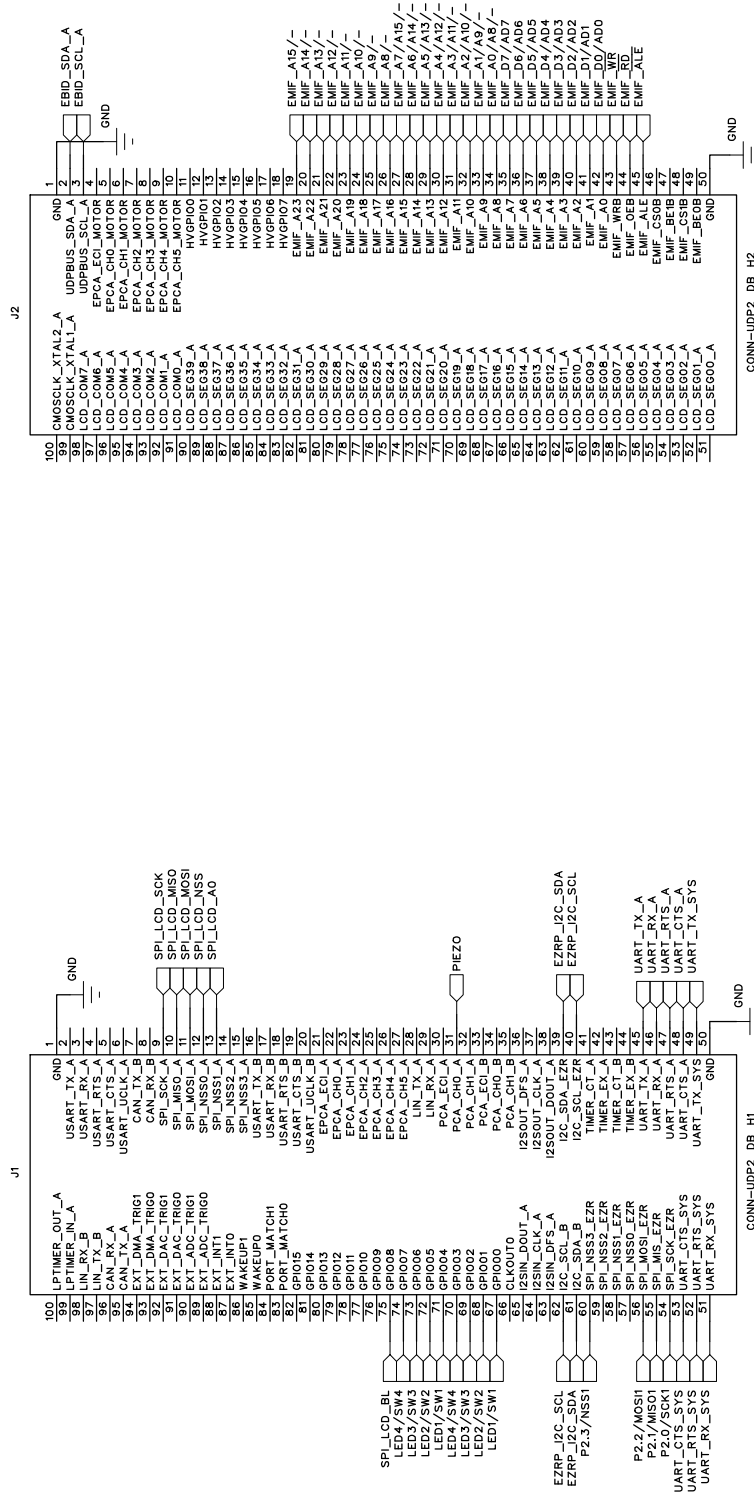

Figure 15. C8051F96x UDP MCU Card Schematic (4 of 6)





UDP Header 1 (Top View) UDP Header 2 (Top View)

Figure 16. C8051F96x UDP MCU Card Schematic (5 of 6)



## 8. Bill of Materials

**Table 3. UDP C8051F960/Si1020 MCU Card with EMIF Bill of Materials**

Reference	Part Number	Source	Description
U2	24AA64T-I/MNY	Microchip Technology	64KBIT I2C SERIAL FLASH, 400KHZ, 8-TDFN
U4-5	SN74AVC4T245PWR	Texas Instruments	Quad Dual-Supply Level Shifter, TSSOP
BT1	12BH1/2AA-2P-GR	Eagle Plastic Devices	HOLDER BATTERY, 1/2 CELL AA, PCB MNT OR EQ, RoHS
C2, C12, R70	06035C103KAT2A	AVX Corporation	CAP, 0.01UF (10000PF), X7R, CERAMIC, 0603, 50V, ±10%, OR EQ, RoHS
C4-8, C10-11, C13	C0603C104J3RACTU	Kemet	CAP, 0.1UF, X7R, CERAMIC, 0603, 25V, ±5%, OR EQ, RoHS
C14	GRM188R71A105KA61D	Murata Electronics North America	CAP CERAMIC, 1.0UF, X5R, 0603, 10V, ±10%, RoHS
C15	GRM188R71A105KA61D	Murata Electronics North America	CAP CERAMIC, 1.0UF, X5R, 0603, 10V, ±10%, RoHS, NOPOP
C1, C3, C9	EMK212BJ475KG-T	Taiyo Yuden	CAP, 4.7UF, X5R, CERAMIC, 0805, 16V, ±10%, OR EQ, RoHS
P1	RAPC722X	Switchcraft Inc	CONN, POWERJACK MINI.08" RA PC MNT, RoHS
J1-4	FX8-100P-SV1(91)	Hirose Electric Co Ltd	CONN, HDR, 100POS, .6MM, GOLD, SMD, RoHS
U63	CP2102	Silicon Labs	SINGLE-CHIP USB TO UART BRIDGE, QFN28, RoHS
D1-4	1N5819HW-7-F	Diodes Inc	DIODE SCHOTTKY, 40V, 1A, SOD123, RoHS
D6	MMSZ5245B-7-F	Diodes Inc	DIODE, ZENER, 15V, 500MW, SMT, SOD123, RoHS
D5	SP0503BAHTG	Littelfuse Inc	TVS AVAL DIODE ARRAY, 3 CH, SOT143, RoHS
J7-8	25631401RP2	Norcomp Inc.	14POS, 2MM VERT SGL ROW RECEPTACLE
J18, J20	PBC02SAAN	Sullins Connector Solutions	STAKE HEADER, 1X2, 0.1"CTR, GOLD, OR EQ, RoHS, NOPOP
P12	PBC04DAAN	Sullins Connector Solutions	STAKE HEADER, 2X4, 0.1"CTR, OR EQ, RoHS
J10	PBC05DAAN	Sullins Connector Solutions	STAKE HEADER, 2X5, 0.1"CTR, GOLD, OR EQ, RoHS
J9, J11-12	PBC09DAAN	Sullins Connector Solutions	STAKE HEADER, 2X9, 0.1" CTR GOLD, OR EQ, RoHS
J5-6	A3C-32DA-2DSC(71)	Hirose Electric Co Ltd	HEADER RECEPTACLE, 32 POS, 2MM, DUAL ROW
J13	N2510-6002-RB	3M	HEADER, SHROUDED, 2X5, OR EQ, RoHS
L1	NLV25T-R68J-PF	TDK	INDUCTOR, POWER, 0.68UH, 1008 SMD, RoHS, NOPOP

# C8051F96x/Si102x

**Table 3. UDP C8051F960/Si1020 MCU Card with EMIF Bill of Materials (Continued)**

Reference	Part Number	Source	Description
DS5, LED1-4	SML-LX0603IW-TR	Lumex Opto/Components Inc	LED, RED DIFF, 635NM, SMT0603, OR EQ, RoHS
U1	LP2989AIMM-3.3/NOPB	National Semiconductor	LDO REG, 500MA, ADJ, MSOP, RoHS
R50	RV100F-30-4K1B-B10K-B301	Alpha (Taiwan)	POT, 10K, THUMBWHEEL LINEAR, 0.03W, ±20%, OR EQ, RoHS
R47	ERJ-3GEYJ104V	Panasonic - ECG	RES, 100K, SMT, 0603, 1/10W, ±5%, OR EQ, RoHS
R41-42	ERJ-3EKF1002V	Panasonic - ECG	RES, EQ. 10.0K OHM, SMT, 0603, 1/10W, ±1%, OR EQ, RoHS
R49, R53	ERJ-3EKF1001V	Panasonic - ECG	RES, 1K OHM, SMT, 0603, 1/10W, ±1%, OR EQ, RoHS
R52	ERJ-3EKF3921V	Panasonic - ECG	RES, 3.92K OHM, SMT, 0603, 1/10W, ±1%, OR EQ, RoHS
R40	ERJ-3EKF4751V	Panasonic - ECG	RES, 4.75K OHM, SMT, 0603, 1/10W, ±1%, OR EQ, RoHS
R48	MCR03EZPJ471	Rohm Semiconductor	RES, 470 OHM, SMT, 0603, 1/10W, ±5%, OR EQ, RoHS
R54-57	ERJ-3EKF7500V	Panasonic - ECG	RES, 750 OHM, SMT, 0603, 1/10W, ±1%, OR EQ, RoHS
R5-8, R11-12, R14, R16, R34-38, R51			RES, SMT, 0603, OR EQ, RoHS, NOPOP
R1-4, R9-10, R13, R15, R17-33, R39, R43-46			0603 SHORT, NOPOP
SW7, SW12	OS102011MS2QN1	C&K Components	SWITCH, SPDT, 12VDC, OR EQ, RoHS
SW1-4, SW6	EVQ-PAD04M	Panasonic - ECG	SWITCH, LIGHT TOUCH, 130GF, 6MM SQ, RoHS
SW5	OS103012MU1QP1	C&K Components	SWITCH SLIDE SP3T COMPACT PIN, PCB MNT, OR EQ, RoHS
J14	1729144	Phoenix Contact	CONN TERM BLOCK, 5.08MM CTRS PCB, 4 POS, RoHS
J17	54819-0519	Molex Inc	CONN, USB MINI RECEPT, 5POS RT ANG, TYPE B OR EQ, RoHS

## APPENDIX—MCU CARD HEADER PIN DESCRIPTIONS

**Table 4. UDP C8051F960/Si1020 MCU Card with EMIF H1 Pin Descriptions (J1)**

MCU Card Pin	Signal Name	Usage
1	GND	
2	USART_TX_A	
3	USART_RX_A	
4	USART_RTS_A	
5	USART_CTS_A	
6	USART_UCLK_A	
7	CAN_TX_B	
8	CAN_RX_B	
9	SPI_SCK_A	Graphical LCD I/O Card SPI clock
10	SPI_MISO_A	Graphical LCD I/O Card SPI master-in, slave-out
11	SPI_MOSI_A	Graphical LCD I/O Card SPI master-out, slave-in
12	SPI_NSS0_A	Graphical LCD I/O Card SPI slave select
13	SPI_NSS1_A	Graphical LCD I/O Card A0 address signal
14	SPI_NSS2_A	
15	SPI_NSS3_A	
16	USART_TX_B	
17	USART_RX_B	
18	USART_RTS_B	
19	USART_CTS_B	
20	USART_UCLK_B	
21	EPCA_ECI_A	
22	EPCA_CH0_A	
23	EPCA_CH1_A	
24	EPCA_CH2_A	
25	EPCA_CH3_A	
26	EPCA_CH4_A	
27	EPCA_CH5_A	
28	LIN_TX_A	
29	LIN_RX_A	
30	PCA_ECI_A	
31	PCA_CH0_A	Graphical LCD I/O Card Piezo
32	PCA_CH1_A	
33	PCA_ECI_B	
34	PCA_CH0_B	
35	PCA_CH1_B	
36	I2SOUT_DFS_A	

# C8051F96x/Si102x

Table 4. UDP C8051F960/Si1020 MCU Card with EMIF H1 Pin Descriptions (J1) (Continued)

MCU Card Pin	Signal Name	Usage
37	I2SOUT_CLK_A	
38	I2SOUT_DOUT_A	
39	I2C_SDA_EZR	EZRadioI2C data
40	I2C_SCL_EZR	EZRadio I2C clock
41	TIMER_CT_A	
42	TIMER_EX_A	
43	TIMER_CT_B	
44	TIMER_EX_B	
45	UART_TX_A	UART A transmit
46	UART_RX_A	UART A receive
47	UART_RTS_A	UART A hardware handshaking
48	UART_CTS_A	UART A hardware handshaking
49	UART_TX_SYS	System UART transmit
50	GND	
51	UART_RX_SYS	System UART receive
52	UART_RTS_SYS	System UART hardware handshaking
53	UART_CTS_SYS	System UART hardware handshaking
54	SPI_SCK_EZR	EZRadioPRO SPI clock (P2.0)
55	SPI_MISO_EZR	EZRadioPRO SPI master-in, slave-out (P2.1)
56	SPI_MOSI_EZR	EZRadioPRO SPI master-out, slave-in (P2.2)
57	SPI_NSS0_EZR	
58	SPI_NSS1_EZR	
59	SPI_NSS2_EZR	
60	SPI_NSS3_EZR	EZRadioPRO SPI slave select (P2.3)
61	I2C_SDA_B	EZRadioPRO I2C data
62	I2C_SCL_B	EZRadioPRO I2C clock
63	I2SIN_DFS_A	
64	I2SIN_CLK_A	
65	I2SIN_DOUT_A	
66	CLKOUT0	
67	GPIO00	LED1/SW1
68	GPIO01	LED2/SW2
69	GPIO02	LED3/SW3
70	GPIO03	LED4/SW4
71	GPIO04	LED1/SW1
72	GPIO05	LED2/SW2
73	GPIO06	LED3/SW3



**Table 4. UDP C8051F960/Si1020 MCU Card with EMIF H1 Pin Descriptions (J1) (Continued)**

MCU Card Pin	Signal Name	Usage
74	GPIO07	LED4/SW4
75	GPIO08	Graphical LCD I/O Card Backlight
76	GPIO09	
77	GPIO10	
78	GPIO11	
79	GPIO12	
80	GPIO13	
81	GPIO14	
82	GPIO15	
83	PORT_MATCH0	
84	PORT_MATCH1	
85	WAKEUP0	
86	WAKEUP1	
87	EXT_INT0	
88	EXT_INT1	
89	EXT_ADC_TRIG0	
90	EXT_ADC_TRIG1	
91	EXT_DAC_TRIG0	
92	EXT_DAC_TRIG1	
93	EXT_DMA_TRIG0	
94	EXT_DMA_TRIG1	
95	CAN_TX_A	
96	CAN_RX_A	
97	LIN_TX_B	
98	LIN_RX_B	
99	LPTIMER_IN_A	
100	LPTIMER_OUT_A	

# C8051F96x/Si102x

**Table 5. UDP C8051F960/Si1020 MCU Card with EMIF H2 Pin Descriptions (J2)**

MCU Card Pin	Signal Name	Description
1	GND	
2	UDPBUS_SDA_A	Electronic Board ID I2C data
3	UDPBUS_SCL_A	Electronic Board ID I2C clock
4	EPCA_ECI_MOTOR	
5	EPCA_CH0_MOTOR	
6	EPCA_CH1_MOTOR	
7	EPCA_CH2_MOTOR	
8	EPCA_CH3_MOTOR	
9	EPCA_CH4_MOTOR	
10	EPCA_CH5_MOTOR	
11	HVGPI00	
12	HVGPI01	
13	HVGPI02	
14	HVGPI03	
15	HVGPI04	
16	HVGPI05	
17	HVGPI06	
18	HVGPI07	
19	EMIF_A23	EMIF A15/- (non-mux/mux)
20	EMIF_A22	EMIF A14/-
21	EMIF_A21	EMIF A13/-)
22	EMIF_A20	EMIF A12/-
23	EMIF_A19	EMIF A11/-
24	EMIF_A18	EMIF A10/-
25	EMIF_A17	EMIF A9/-
26	EMIF_A16	EMIF A8/-
27	EMIF_A15	EMIF A7/A15/- (non-mux/16-bit mux/8-bit mux)
28	EMIF_A14	EMIF A6/A14/-
29	EMIF_A13	EMIF A5/A13/-
30	EMIF_A12	EMIF A4A12/-
31	EMIF_A11	EMIF A3/A11/-
32	EMIF_A10	EMIF A2/A10/-
33	EMIF_A9	EMIF A1/A9/-
34	EMIF_A8	EMIF A0/A8/-
35	EMIF_A7	EMIF D7/AD7 (non-mux/mux)
36	EMIF_A6	EMIF D6/AD6
37	EMIF_A5	EMIF D5/AD5

**Table 5. UDP C8051F960/Si1020 MCU Card with EMIF H2 Pin Descriptions (J2)**

MCU Card Pin	Signal Name	Description
38	EMIF_A4	EMIF D4/AD4
39	EMIF_A3	EMIF D3/AD3
40	EMIF_A2	EMIF D2/AD2
41	EMIF_A1	EMIF D1/AD1
42	EMIF_A0	EMIF D0/AD0
43	EMIF_WRB	EMIF write signal (active low)
44	EMIF_OEB	EMIF Read (active low)
45	EMIF_ALE	EMIF address latch enable
46	EMIF_CS0B	
47	EMIF_BE1B	
48	EMIF_CS1B	
49	EMIF_BE0B	
50	GND	
51	LCD_SEG00_A	
52	LCD_SEG01_A	
53	LCD_SEG02_A	
54	LCD_SEG03_A	
55	LCD_SEG04_A	
56	LCD_SEG05_A	
57	LCD_SEG06_A	
58	LCD_SEG07_A	
59	LCD_SEG08_A	
60	LCD_SEG09_A	
61	LCD_SEG10_A	
62	LCD_SEG11_A	
63	LCD_SEG12_A	
64	LCD_SEG13_A	
65	LCD_SEG14_A	
66	LCD_SEG15_A	
67	LCD_SEG16_A	
68	LCD_SEG17_A	
69	LCD_SEG18_A	
70	LCD_SEG19_A	
71	LCD_SEG20_A	
72	LCD_SEG21_A	
73	LCD_SEG22_A	
74	LCD_SEG23_A	

# C8051F96x/Si102x

Table 5. UDP C8051F960/Si1020 MCU Card with EMIF H2 Pin Descriptions (J2)

MCU Card Pin	Signal Name	Description
75	LCD_SEG24_A	
76	LCD_SEG25_A	
77	LCD_SEG26_A	
78	LCD_SEG27_A	
79	LCD_SEG28_A	
80	LCD_SEG29_A	
81	LCD_SEG30_A	
82	LCD_SEG31_A	
83	LCD_SEG32_A	
84	LCD_SEG33_A	
85	LCD_SEG34_A	
86	LCD_SEG35_A	
87	LCD_SEG36_A	
88	LCD_SEG37_A	
89	LCD_SEG38_A	
90	LCD_SEG39_A	
91	LCD_COM0_A	
92	LCD_COM1_A	
93	LCD_COM2_A	
94	LCD_COM3_A	
95	LCD_COM4_A	
96	LCD_COM5_A	
97	LCD_COM6_A	
98	LCD_COM7_A	
99	CMOSCLK_XTAL1_A	
100	CMOSCLK_XTAL2_A	

**Table 6. UDP C8051F960/Si1020 MCU Card with EMIF H3 Pin Descriptions (J3)**

MCU Card Pin	Description	Description
1	GND	
2	PWR_VDD_IN	
3	PWR_VDD_IN	
4	PWR_VDD_OUT	Programmable Supply from UDP to VBAT (VBAT Select set to UDP)
5	PWR_VDD_OUT	
6	PWR_RADIO_IN	VDC Output of DCDC to power 40-pin radio card
7	PWR_RADIO_IN	
8	PWR_RADIO_OUT	Power input for the radio card
9	PWR_RADIO_OUT	Power input for the radio card
10	PWR_IO_IN	VIO (controlled by VIO select)
11	PWR_IO_IN	
12	PWR_IO_OUT	
13	PWR_IO_OUT	
14	PWR_IO_BUS	VIO (controlled by VIO select)
15	PWR_IO_BUS	
16	PWR_AUX_BUS	
17	PWR_AUX_BUS	
18	PWR_HV1_BUS	
19	PWR_HV1_BUS	
20	PWR_HV2_BUS	
21	PWR_HV2_BUS	
22	PWR_VPP_BULK	
23	PWR_VPP_BULK	
24	PWR_5.0_BULK	5.0 V power from the UDP motherboard (Powers MCU Card regulator)
25	PWR_5.0_BULK	
26	PWR_5.0_BULK	
27	PWR_5.0_BULK	
28	VCC_3.3V	
29	VCC_3.3V	
30	VCC_3.3V	
31	VCC_3.3V	
32	PWR_SYS_BULK	3.3 V power supply for EBID EEPROM
33	PWR_SYS_BULK	
34	GND	
35	EBID_SCK	RF EBID SPI clock
36	EBID_MOSI	RF EBID SPI master-out, slave in
37	EBID_MISO	RF EBID SPI master-in, slave-out

# C8051F96x/Si102x

Table 6. UDP C8051F960/Si1020 MCU Card with EMIF H3 Pin Descriptions (J3)

MCU Card Pin	Description	Description
38	EBID_NSS	RF EBID SPI slave select
39	C2_CLK_A	Reset/C2 interface clock
40	C2_DAT_A	P7.0/C2 interface data
41	C2_CLK_B	
42	C2_DAT_B	
43	C2_CLK_C	
44	C2_DAT_C	
45	C2_CLK_D	
46	C2_DAT_D	
47	C2_CLK_E	
48	C2_DAT_E	
49	nc	
50	GND	
51	JTAG_TDO_A	
52	JTAG_TDI_A	
53	VCP_EN	Active-low enable for MCU Card VCP Bridge (default)
54	UART_SYS_EN	Active-low enable for MCU to UDP UART path
55	H3_55	
56	H3_56	
57	H3_57	
58	H3_58	
59	H3_59	
60	H3_60	
61	H3_61	
62	H3_62	
63	H3_63	
64	H3_64	
65	H3_65	
66	H3_66	
67	H3_67	
68	H3_68	
69	H3_69	
70	H3_70	
71	H3_71	
72	H3_72	
73	H3_73	
74	H3_74	

**Table 6. UDP C8051F960/Si1020 MCU Card with EMIF H3 Pin Descriptions (J3)**

<b>MCU Card Pin</b>	<b>Description</b>	<b>Description</b>
75	H3_75	
76	H3_76	
77	H3_77	
78	H3_78	
79	H3_79	
80	H3_80	
81	H3_81	
82	H3_82	
83	H3_83	
84	H3_84	
85	H3_85	
86	H3_86	
87	H3_87	
88	H3_88	
89	H3_89	
90	H3_90	
91	H3_91	
92	H3_92	
93	H3_93	
94	H3_94	
95	H3_95	
96	H3_96	
97	H3_97	
98	H3_98	
99	H3_99	
100	H3_100	



**Table 7. UDP C8051F960/Si1020 MCU Card with EMIF H4 Pin Descriptions (J4)**

MCU Card Pin	Description	Description
1	GND	
2	C2D_TX00_A	Capacitive Sensing output 0
3	C2D_TX01_A	Capacitive Sensing output 1
4	C2D_TX02_A	Capacitive Sensing output 2
5	C2D_TX03_A	Capacitive Sensing output 3
6	C2D_TX04_A	Capacitive Sensing output 4
7	C2D_TX05_A	Capacitive Sensing output 5
8	C2D_TX06_A	Capacitive Sensing output 6
9	C2D_TX07_A	Capacitive Sensing output 7
10	C2D_TX08_A	Capacitive Sensing output 8
11	C2D_TX09_A	Capacitive Sensing output 9
12	C2D_TX10_A	Capacitive Sensing output 10
13	C2D_TX11_A	Capacitive Sensing output 11
14	C2D_TX12_A	Capacitive Sensing output 12
15	C2D_TX13_A	Capacitive Sensing output 13
16	C2D_TX14_A	Capacitive Sensing output 14
17	C2D_TX15_A	Capacitive Sensing output 15
18	C2D_RX00_A	Capacitive Sensing input 0
19	C2D_RX01_A	Capacitive Sensing input 1
20	C2D_RX02_A	Capacitive Sensing input 2
21	C2D_RX03_A	Capacitive Sensing input 3
22	C2D_RX04_A	Capacitive Sensing input 4
23	C2D_RX05_A	Capacitive Sensing input 5
24	C2D_RX06_A	Capacitive Sensing input 6
25	C2D_RX07_A	Capacitive Sensing input 7
26	C2D_RX08_A	Capacitive Sensing input 8
27	C2D_RX09_A	Capacitive Sensing input 9
28	C2D_RX10_A	Capacitive Sensing input 10
29	C2D_RX11_A	Capacitive Sensing input 11
30	C2D_RX12_A	Capacitive Sensing input 12
31	C2D_RX13_A	Capacitive Sensing input 13
32	C2D_RX14_A	Capacitive Sensing input 14
33	C2D_RX15_A	Capacitive Sensing input 15
34	GND	
35	ADC_VREF	ADC voltage reference
36	ADC_VREFGND	ADC VREF ground
37	ADC_IN0	

**Table 7. UDP C8051F960/Si1020 MCU Card with EMIF H4 Pin Descriptions (J4) (Continued)**

MCU Card Pin	Description	Description
38	ADC_IN1	
39	ADC_IN2	
40	ADC_IN3	
41	GND	
42	DAC_VREF	DAC voltage reference
43	DAC_VREFGND	DAC voltage reference ground
44	DAC_OUT0	
45	DAC_OUT1	
46	DAC_OUT2	
47	DAC_OUT3	
48	GND	
49	IDAC_A	IDAC A output
50	IDAC_B	IDAC B output
51	CP_OUT_A	Comparator A synchronous output
52	CP_OUTA_A	Comparator A asynchronous output
53	CP_POS_A	Comparator A positive input
54	CP_NEG_A	Comparator A negative input
55	CP_POS_B	Comparator B positive input
56	CP_NEG_B	Comparator B negative input
57	GND	
58	HVDA_INP_A	High Voltage Differential Amplifier A positive input
59	HVDA_INN_A	High Voltage Differential Amplifier A negative input
60	HVDA_INP_B	High Voltage Differential Amplifier B positive input
61	HVDA_INN_B	High Voltage Differential Amplifier B negative input
62	GND	
63	I2V_INP_A	Current-to-Voltage converter A input 0
64	I2V_INN_A	Current-to-Voltage converter A input 1
65	EXTREG_SP_A	External Voltage Regulator SP input
66	EXTREG_SN_A	External Voltage Regulator SN input
67	EXTREG_OUT_A	External Voltage Regulator OUT output
68	EXTREG_BD_A	External Voltage Regulator base drive output
69	GND	
70	EZRP_CLK_IN	Radio card clock input (SMA connector)
71	GND	
72	EZRP_TX_DATA_IN	Radio card transmit data input (SMA connector)
73	EZRO_RX_CLK_OUT	Radio card receive clock output (SMA connector)
74	EZRP_RX_DATA_OUT	Radio card receive data output (SMA connector)

# C8051F96x/Si102x

Table 7. UDP C8051F960/Si1020 MCU Card with EMIF H4 Pin Descriptions (J4) (Continued)

MCU Card Pin	Description	Description
75	GND	
76	EZRP_SDN	Radio card peripheral shutdown
77	EZRP_NIRQ	Radio card peripheral interrupt status
78	EZR_NFFS	
79	EZR_SI100X_TX	Radio card Si100x transmit
80	EZR_DTO	
81	EZR_FFIT	
82	EZR_SI100X_RX	Radio card Si100x receive
83	EZR_RESET	Radio card reset
84	EZR_ARSSI	
85	EZR_VDI	
86	EZR_GPIO0	Radio card general purpose I/O 0
87	EZR_GPIO1	Radio card general purpose I/O 1
88	EZR_GPIO2	Radio card general purpose I/O 2
89	EZR_GPIO3	Radio card general purpose I/O 3
90	EZR_GPIO4	Radio card general purpose I/O 4
91	H4_91	General purpose signal
92	ITM_DAT0	
93	ITM_DAT1	
94	ITM_DAT2	
95	ITM_DAT3	
96	ITM_CLK	
97	H4_97	General purpose signal
98	H4_98	General purpose signal
99	H4_99	General purpose signal
100	GND	



## Simplicity Studio

One-click access to MCU and wireless tools, documentation, software, source code libraries & more. Available for Windows, Mac and Linux!



**IoT Portfolio**  
[www.silabs.com/IoT](http://www.silabs.com/IoT)



**SW/HW**  
[www.silabs.com/simplicity](http://www.silabs.com/simplicity)



**Quality**  
[www.silabs.com/quality](http://www.silabs.com/quality)



**Support and Community**  
[community.silabs.com](http://community.silabs.com)

### Disclaimer

Silicon Laboratories intends to provide customers with the latest, accurate, and in-depth documentation of all peripherals and modules available for system and software implementers using or intending to use the Silicon Laboratories products. Characterization data, available modules and peripherals, memory sizes and memory addresses refer to each specific device, and "Typical" parameters provided can and do vary in different applications. Application examples described herein are for illustrative purposes only. Silicon Laboratories reserves the right to make changes without further notice and limitation to product information, specifications, and descriptions herein, and does not give warranties as to the accuracy or completeness of the included information. Silicon Laboratories shall have no liability for the consequences of use of the information supplied herein. This document does not imply or express copyright licenses granted hereunder to design or fabricate any integrated circuits. The products must not be used within any Life Support System without the specific written consent of Silicon Laboratories. A "Life Support System" is any product or system intended to support or sustain life and/or health, which, if it fails, can be reasonably expected to result in significant personal injury or death. Silicon Laboratories products are generally not intended for military applications. Silicon Laboratories products shall under no circumstances be used in weapons of mass destruction including (but not limited to) nuclear, biological or chemical weapons, or missiles capable of delivering such weapons.

### Trademark Information

Silicon Laboratories Inc., Silicon Laboratories, Silicon Labs, SiLabs and the Silicon Labs logo, CMEMS®, EFM, EFM32, EFR, Energy Micro, Energy Micro logo and combinations thereof, "the world's most energy friendly microcontrollers", Ember®, EZLink®, EZMac®, EZRadio®, EZRadioPRO®, DSPLL®, ISOmodem®, Precision32®, ProSLIC®, SiPHY®, USBXpress® and others are trademarks or registered trademarks of Silicon Laboratories Inc. ARM, CORTEX, Cortex-M3 and THUMB are trademarks or registered trademarks of ARM Holdings. Keil is a registered trademark of ARM Limited. All other products or brand names mentioned herein are trademarks of their respective holders.



**SILICON LABS**

Silicon Laboratories Inc.  
 400 West Cesar Chavez  
 Austin, TX 78701  
 USA

<http://www.silabs.com>