

---

# UDP C8051F390/F370 MCU CARD USER'S GUIDE

---

## 1. Introduction

The Unified Development Platform (UDP) provides a development and demonstration platform for Silicon Laboratories microcontrollers and the Silicon Laboratories software tools, including the Silicon Laboratories Integrated Development Environment (IDE).

**Note:** The C8051F39x/F37x family has two MCU cards, one for the C8051F39x devices and one for the C8051F37x devices. The information in this document applies to both sets of hardware, and the examples (with the exception of the EEPROM) will run on both.

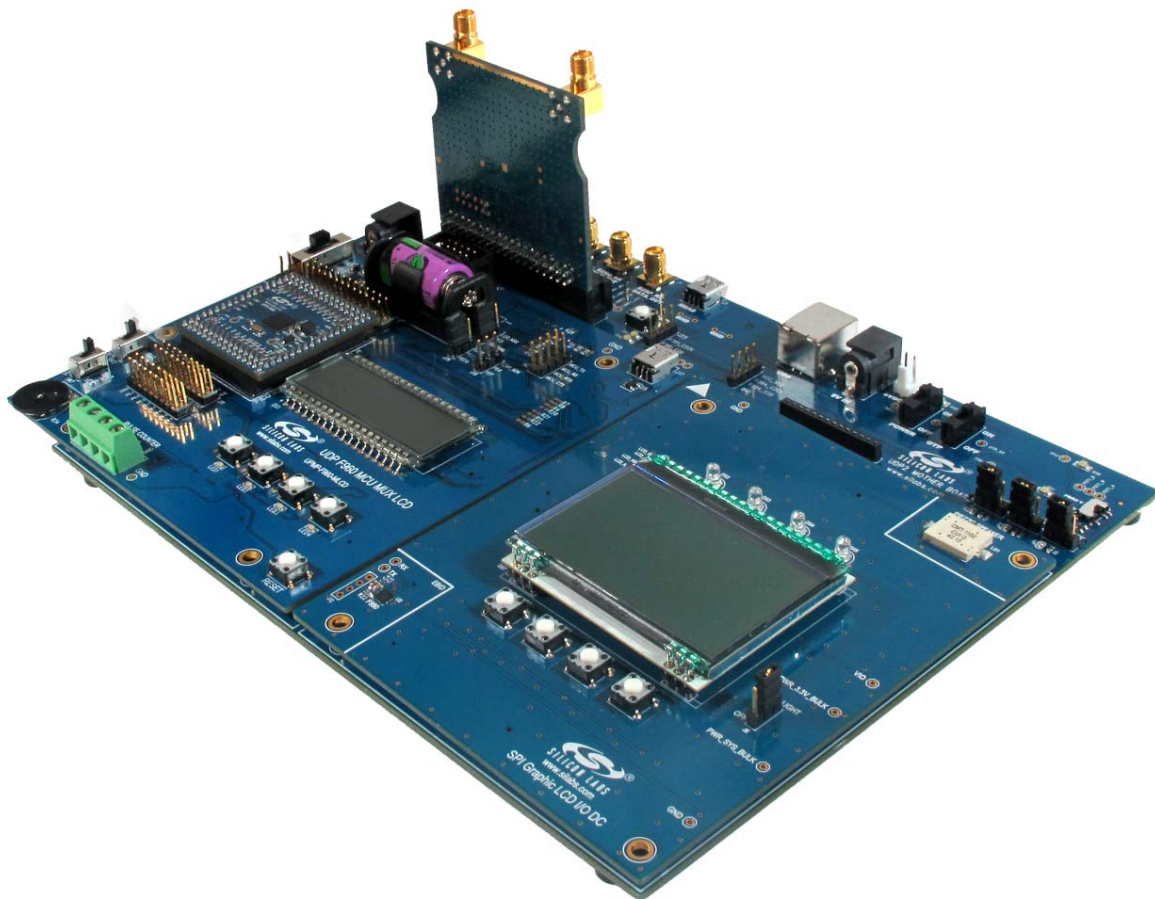

Figure 1. Unified Development Platform

## 2. Relevant Documents

This document provides a hardware overview for the Unified Development Platform (UDP) system UDP C8051F390/F370 MCU Card. Additional information on the UDP system can be found in the documents listed in this section.

- Motherboard User's Guide: The UDP Motherboard User's Guide contains information on the motherboard features and can be found at [www.silabs.com](http://www.silabs.com).
- Card User's Guides: The UDP MCU Card and Radio Card User's Guides can be found at [www.silabs.com](http://www.silabs.com).

# C8051F39x/F37x

## 3. Hardware Setup

### 3.1. Using the MCU Card Alone

Refer to Figure 2 for a diagram of the hardware configuration when using the MCU card without a UDP motherboard.

1. Connect the USB Debug Adapter to the 2x5 debug connector on the MCU card with the 10-pin ribbon cable.
2. Connect one end of the USB cable to the USB connector on the USB Debug Adapter.
3. Connect the other end of the USB cable to a USB Port on the PC.
4. Move the SW1 switch to the VREG position.
5. Connect the 9 V DC adapter to P1.

#### Notes:

- Use the Reset button in the IDE to reset the target when connected using a USB Debug Adapter.
- Remove power from the MCU card and the USB Debug Adapter before connecting or disconnecting the ribbon cable from the MCU card. Connecting or disconnecting the cable when the devices have power can damage the device and/or the USB Debug Adapter.

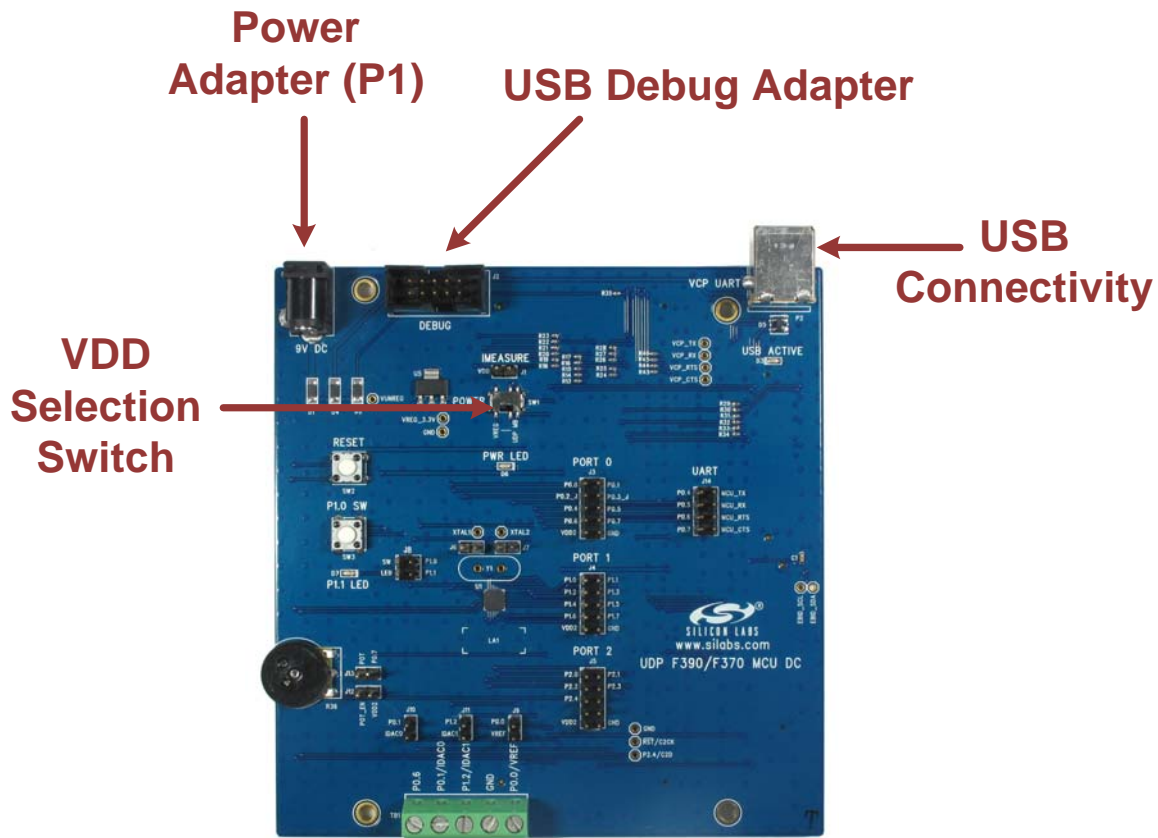

Figure 2. Hardware Setup Using the MCU Card Alone

### 3.2. Using the MCU Card with the UDP Motherboard

Refer to Figure 3 for a diagram of the hardware configuration when using the MCU card with a UDP motherboard.

1. Connect the MCU card to the UDP motherboard slot.
2. (Optional) Connect the I/O card to the UDP motherboard slot.
3. (Optional) Connect a radio card to the radio card slot in the UDP motherboard.
4. (Optional) Connect an EZLink card to the EZLink card slot in the UDP motherboard.
5. Connect the USB Debug Adapter to the 2x5 debug connector on the MCU card with the 10-pin ribbon cable.
6. Connect one end of the USB cable to the USB connector on the USB Debug Adapter.
7. Connect the other end of the USB cable to a USB Port on the PC.
8. Connect the ac/dc power adapter to power jack J20 on the UDP motherboard. The board can also be powered from the J16 USB or J1 mini USB connectors.
9. Move the SW1 switch on the MCU card to the UDP MB position.
10. Move the S3 power switch on the UDP motherboard to the ON position.

#### Notes:

- Use the Reset button in the IDE to reset the target when connected using a USB Debug Adapter.
- Remove power from the target board and the USB Debug Adapter before connecting or disconnecting the ribbon cable from the target board. Connecting or disconnecting the cable when the devices have power can damage the device and/or the USB Debug Adapter.
- The MCU card can be used alone without the motherboard. However, the motherboard must be powered if an MCU card is connected.

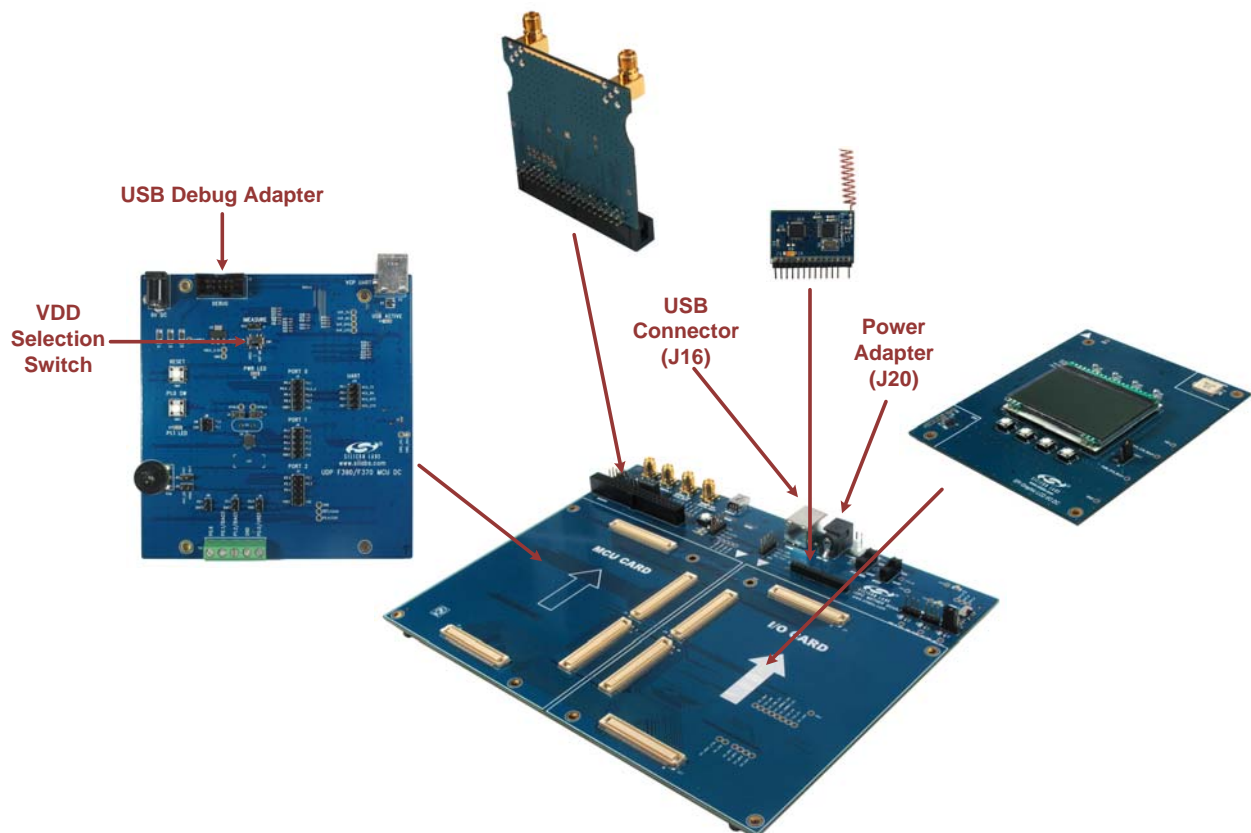

Figure 3. Hardware Setup Using the Unified Development Platform

# C8051F39x/F37x

## 4. Software Setup

Simplicity Studio greatly reduces development time and complexity with Silicon Labs EFM32 and 8051 MCU products by providing a high-powered IDE, tools for hardware configuration, and links to helpful resources, all in one place.

Once Simplicity Studio is installed, the application itself can be used to install additional software and documentation components to aid in the development and evaluation process.

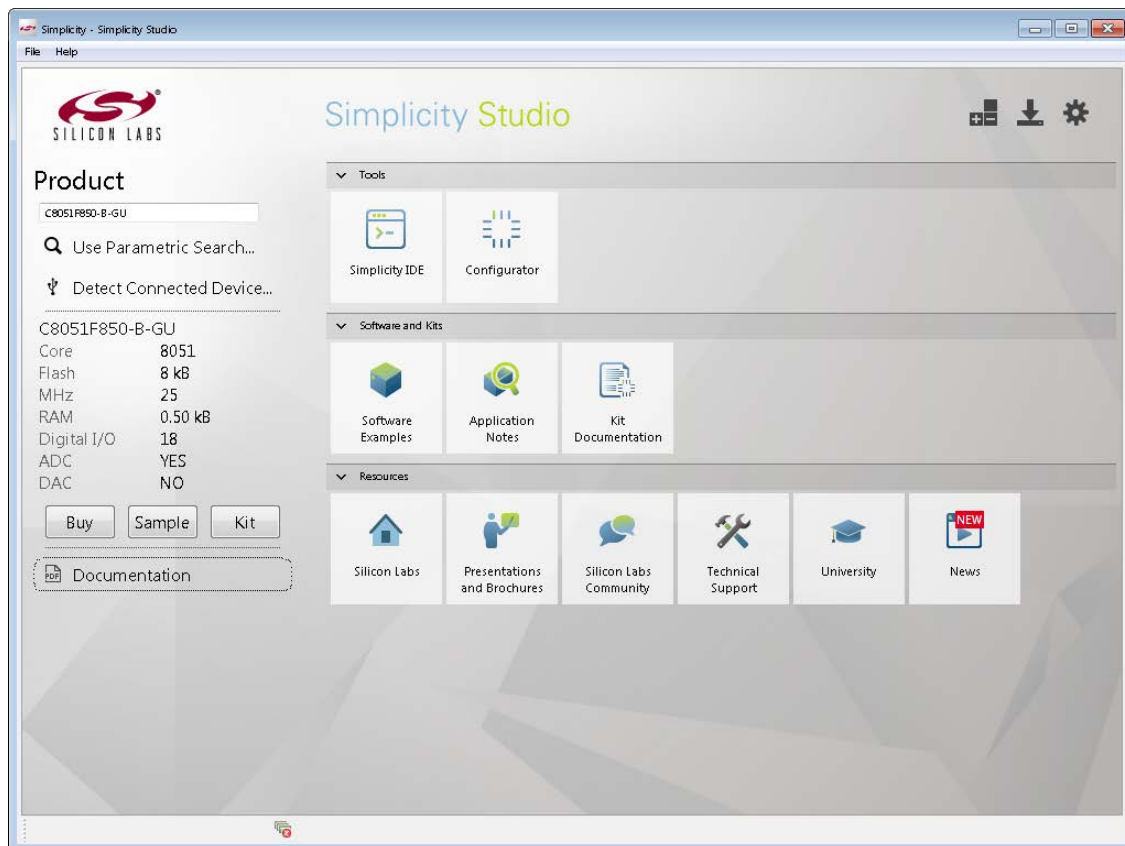

**Figure 4. Simplicity Studio**

The following Simplicity Studio components are required for the C8051F390 Development Kit:

- 8051 Products Part Support
- Simplicity Developer Platform

Download and install Simplicity Studio from [www.silabs.com/8bit-software](http://www.silabs.com/8bit-software) or [www.silabs.com/simplicity-studio](http://www.silabs.com/simplicity-studio). Once installed, run Simplicity Studio by selecting **Start**→**Silicon Labs**→**Simplicity Studio**→**Simplicity Studio** from the start menu or clicking the **Simplicity Studio** shortcut on the desktop. Follow the instructions to install the software and click **Simplicity IDE** to launch the IDE.

The first time the project creation wizard runs, the **Setup Environment** wizard will guide the user through the process of configuring the build tools and SDK selection.

In the **Part Selection** step of the wizard, select from the list of installed parts only the parts to use during development. Choosing parts and families in this step affects the displayed or filtered parts in the later device selection menus. Choose the C8051F39x family by checking the **C8051F39x/37x** check box. Modify the part selection at any time by accessing the **Part Management** dialog from the **Window**→**Preferences**→**Simplicity Studio**→**Part Management** menu item.

Simplicity Studio can detect if certain toolchains are not activated. If the **Licensing Helper** is displayed after completing the **Setup Environment** wizard, follow the instructions to activate the toolchain.

## 4.1. Running Blinky

Each project has its own source files, target configuration, SDK configuration, and build configurations such as the **Debug** and **Release** build configurations. The IDE can be used to manage multiple projects in a collection called a workspace. Workspace settings are applied globally to all projects within the workspace. This can include settings such as key bindings, window preferences, and code style and formatting options. Project actions, such as build and debug are context sensitive. For example, the user must select a project in the **Project Explorer** view in order to build that project.

To create a project based on the Blinky example:

1. Click the **Simplicity IDE** tile from the Simplicity Studio home screen.
2. Click the **Create new project** link from the welcome screen or go to **File**→**New**→**Silicon Labs MCU Project**.
3. In the **Kit** drop-down, select **C8051F390 Development Kit**, in the **Part** drop-down, select **C8051F390**, and in the **SDK** drop-down, select the desired SDK. Click **Next**.
4. Select **Example** and click **Next**.
5. Under **C8051F390 Development Kit** in the **Blinky** folder, select **F39x-37x Blinky** and click **Finish**.
6. Click on the project in the **Project Explorer** and click **Build**, the hammer icon in the top bar. Alternatively, go to **Project**→**Build Project**.
7. Click **Debug** to download the project to the hardware and start a debug session.
8. Press the **Resume** button to start the code running. The LED should blink.



9. Press the **Suspend** button to stop the code.



10. Press the **Reset the device** button to reset the target MCU.



11. Press the **Disconnect** button to return to the development perspective.



## 4.2. Simplicity Studio Help

Simplicity Studio includes detailed help information and device documentation within the tool. The help contains descriptions for each dialog window. To view the documentation for a dialog, click the question mark icon in the window:



This will open a pane specific to the dialog with additional details.

The documentation within the tool can also be viewed by going to **Help**→**Help Contents** or **Help**→**Search**.

# C8051F39x/F37x

## 4.3. Legacy 8-bit IDE

**Note:** Using the Simplicity Studio tools with the C8051F390 Development Kit is recommended. See section 4. "Software Setup," on page 4 for more information.

Download the 8-bit software from the website ([www.silabs.com/8bit-software](http://www.silabs.com/8bit-software)) or use the provided installer on the CD-ROM to install the software tools for the C8051F39x devices. After installation, examples can be found in ...\\Examples\\C8051F39x\_37x in the installation directory. At a minimum, the C8051F390 DK requires:

- **Silicon Labs IDE**—Software enabling initial evaluation, development, and debugging.
- **Configuration Wizard 2**—Initialization code generation software for the C8051F39x devices.
- **Keil C51 Tools**—Keil 8051 Compiler/Assembler/Linker toolchain.
- **CP210x Drivers**—Virtual COM Port (VCP) drivers for the CP210x COM interface. More information on this installation process can be found in Section 4.4.

Other software available includes:

- **Keil  $\mu$ Vision Driver**—Driver for the Keil  $\mu$ Vision IDE that enables development and debugging on C8051Fxxx MCUs.
- **Flash Programming Utilities and MCU Production Programmer**—Programming utilities for the production line. More information on the available programming options can be found on the website: <http://www.silabs.com/products/mcu/Pages/ProgrammingOptions.aspx>.
- **ToolStick Development Tools**—Software and examples for the ToolStick development platform. More information on this platform can be found at [www.silabs.com/toolstick](http://www.silabs.com/toolstick).

The development kit includes the latest version of the C51 Keil 8051 toolset. This toolset is initially limited to a code size of 2 kB and programs start at code address 0x0800. After registration, the code size limit is removed entirely and programs will start at code address 0x0000.

To register the Keil toolset:

1. Find the **Product Serial Number** printed on the CD-ROM. If you no longer have this serial number, register on the Silicon Labs website ([www.silabs.com/8bit-software](http://www.silabs.com/8bit-software)) to obtain the serial number.
2. Open the Keil  $\mu$ Vision4 IDE from the installation directory with administrative privileges.
3. Select **File**→**License Management** to open the License Management window.

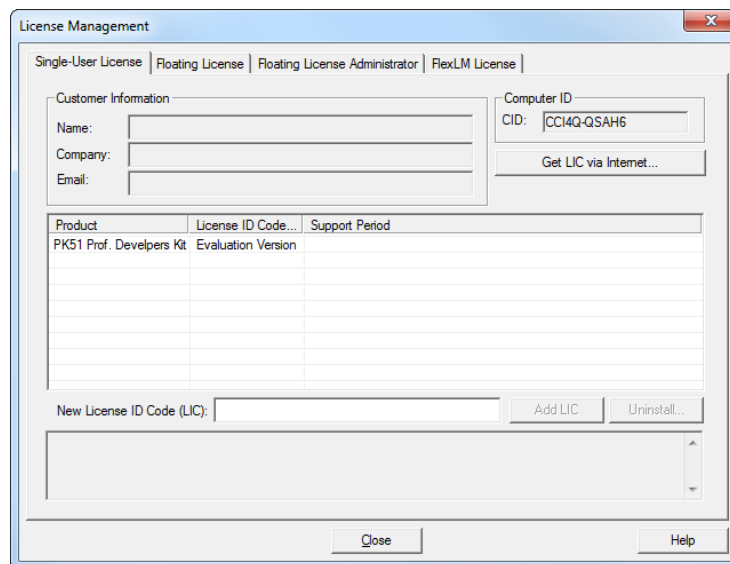

**Figure 5. Keil  $\mu$ Vision4 IDE License Management Window**

4. Click on the **Get LIC via Internet...** button to open the Obtaining a License IDE Code (LIC) window.
5. Press **OK** to open a browser window to the Keil website. If the window doesn't open, navigate to

[www.keil.com/license/install.htm](http://www.keil.com/license/install.htm).

6. Enter the Silicon Labs **Product Serial Number** printed on the CD-ROM, along with any additional required information.
7. Once the form is complete, click the **Submit** button. An email will be sent to the provided email address with the license activation code.
8. Copy the License ID Code (LIC) from the email.
9. Paste the LIC into the **New License ID Code (LIC)** text box at the bottom of the License Management window in  $\mu$ Vision4.
10. Press the **Add LIC** button. The window should now list the **PK51 Prof. Developers Kit for Silabs** as a licensed product.
11. Click the **Close** button.

#### 4.4. CP210x USB to UART VCP Driver Installation

The MCU Card includes a Silicon Labs CP210x USB-to-UART Bridge Controller. Device drivers for the CP210x need to be installed before the PC software can communicate with the MCU through the UART interface. Use the drivers included CD-ROM or download the latest drivers from the website ([www.silabs.com/interface-software](http://www.silabs.com/interface-software)).

1. If using the CD-ROM, the **CP210x Drivers** option will launch the appropriate driver installer. If downloading the driver package from the website, unzip the files to a location and run the appropriate installer for the system (x86 or x64).
2. Accept the license agreement and follow the steps to install the driver on the system. The installer will let you know when your system is up to date. The driver files included in this installation have been certified by Microsoft.
3. To complete the installation process, connect the included USB cable between the host computer and the **COM PORT** USB connector (J5) on the MCU Card. Windows will automatically finish the driver installation. Information windows will pop up from the taskbar to show the installation progress.
4. If needed, the driver files can be uninstalled by selecting **Windows Driver Package—Silicon Laboratories...** option in the **Programs and Features** window.

# C8051F39x/F37x

## 5. UDP C8051F390/F370 MCU Card Overview

The C8051F39x/F37x MCU cards enable application development on the C8051F390 or C8051F370 MCU. The card connects to the MCU Card expansion slot on the UDP motherboard and provides complete access to the MCU resources. Each expansion board has a unique ID that can be read out of an EEPROM or MCU on the board, which enables software tools to recognize the connected hardware and automatically select the appropriate firmware image. The target MCU card can also be detached from the UDP and used alone as a development or demonstration tool.

Figure 6 shows the C8051F390 MCU card.

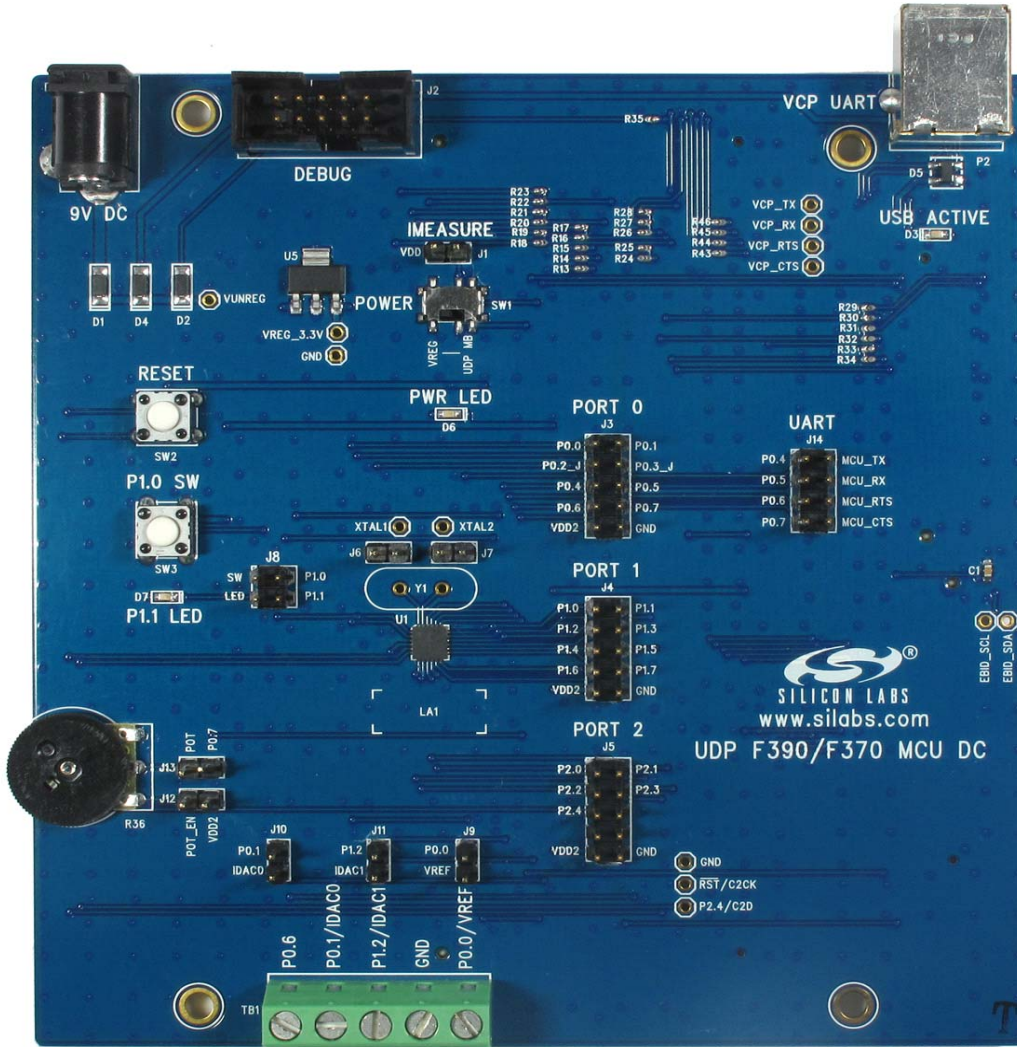

Figure 6. C8051F39x UDP MCU Card

Figure 7 highlights some of the features of the UDP C8051F390/F370 MCU Card.



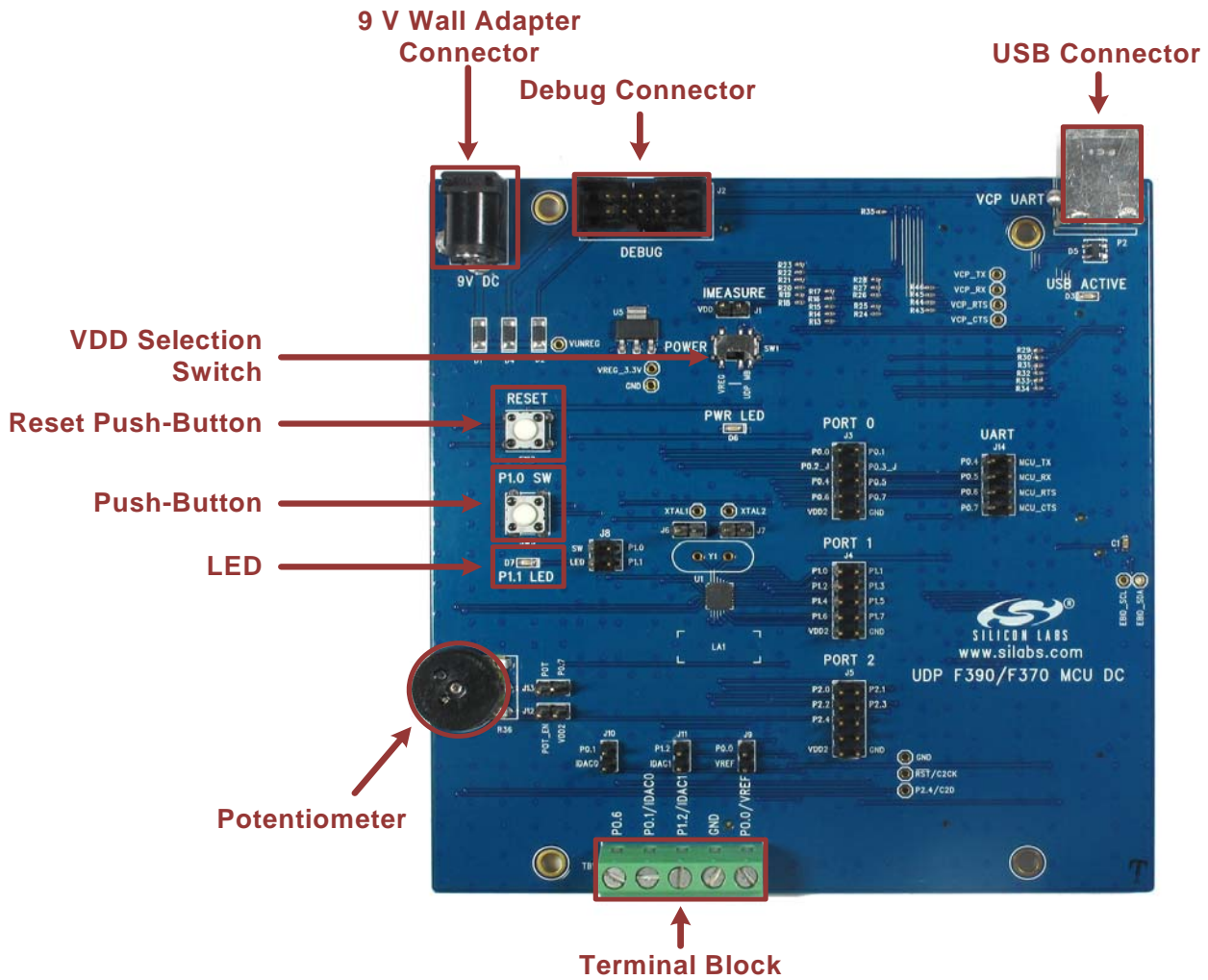

Figure 7. UDP C8051F390/F370 MCU Card

## 5.1. VDD Selection Switch (SW1)

The UDP C8051F390/F370 MCU Card has two power options. The VDD selector switch (SW1) selects the power source for the C8051F39x/F37x VDD supply pin and the supply for the external peripheral circuits, VDD2.

The left VREG position selects the output of the on-board 3.3 V regulator (U5) for VDD and VDD2. This is the primary supply option for development. The on-board regulator has multiple 5 V and 9 V power sources connected via Schottky diodes to the regulator input. The highest voltage power source will supply power to the regulator.

The power sources for the on-board regulator (U1) are as follows:

- 9 V DC Wall Adapter power receptacle (P1).
- USB receptacle (P2).
- 10-pin Debug connector (J2).

The UDP MB position on the VDD selector selects the UDP motherboard programmable supply (PWR\_VDD\_OUT) as the power source. Use this position when using the programmable power supply under software control. The UDP motherboard bulk 3.3 V supply (UDP\_PWR\_3.3V\_BULK) supplies VDD2.

The VDD voltage is available on the J1 header. Ground is accessible at various test points on the MCU card, such as header J3, J4, and J5. Use these test points to power the board from an external lab power supply. When using a lab supply, the VDD selector switch should be in the UDP MB position with the MCU card disconnected from the UDP motherboard.

The MCU card facilitates measurement of the MCU supply current by removing the R1 0  $\Omega$  resistor and placing a current meter in series with the two terminals of the J1 header.

## 5.2. Push-Button Switches and LEDs (SW3, D7)

The UDP C8051F390/F370 MCU Card has one push-button switch. Connect to switch to port pin P1.0 by placing a shorting block on J8: SW - P1.0. The switch is normally open and pulls the pin voltage to ground when pressed.

Port pin P1.1 connects to one LED: D7 when a shorting block is placed on J8: LED - P1.1. The LEDs connect to VDD2 through a current limiting resistor.

## 5.3. Debug Header (J2)

The standard 10-pin debug header supports the Silicon Labs USB Debug Adapter. This connector provides a C2 debug connection to C8051F39x/F37x. The USB Debug Adapter supports two types of debug connections: C2 and JTAG. When using this MCU card with the Silicon Labs IDE, select C2 in the connection options dialog before connecting.

The USB Debug Adapter also provides a 5 V power source that can power the regulator. When powering the MCU from the debug connector, the SW1 switch must be in the VREG position. Additionally, select the Power Target after Disconnect check box in the Silicon Labs IDE connections options dialog to ensure the MCU always has power.

## 5.4. Reset Button (SW2)

The reset push-button switch is in the lower-right corner. Pushing this button will always reset the MCU. Note that pushing this button while the IDE is connected to the MCU will result in the IDE disconnecting from the target.

## 5.5. UART VCP Connection Options

The MCU card features a USB virtual COM port (VCP) UART connection via the USB connector (P2). The VCP connection uses the CP2102 USB-to-UART bridge chip.

The UART pins on the target MCU either connect to the CP2102 USB-to-UART bridge chip or to the UDP motherboard. The MCU card has level translators with enable pins that normally route the UART connections to the on-board USB-to-UART bridge chip. However, the UDP motherboard can drive the enable pins to route the UART connections to the UDP motherboard instead of the on-board USB-to-UART bridge chip. There are two enable signals: one with a default pull-down (UART\_VCP\_EN) and one with a default pull-up (UART\_SYS\_EN).

When using the UART with either the on-board USB-to-UART bridge or the UDP motherboard, install shorting blocks on header J14 to connect P0.4 to MCU\_TX and P0.5 to MCU\_RX.

If desired, install shorting blocks for hardware handshaking on P0.6 and P0.7 on the J14 header. Hardware handshaking is not required for most applications. Firmware must implement hardware handshaking on the target MCU using P0.6 and P0.7.

## 5.6. Potentiometer (R36)

The potentiometer is available on P0.7 when a shorting block is placed on J13. To enable the potentiometer, place a shorting block on J12 to connect the top terminal of the potentiometer to VDD2.

## 5.7. Screw Terminal (TB1)

The MCU card includes a 5-position screw terminal connection capable of accepting large wires in the field. P0.6, P0.1/IDAC0, P0.2/IDAC1, ground, and P0.0/VREF are available.

Before the VREF output can be observed on TB1, place a shorting block on J9 which connects P0.0/VREF to 4.7  $\mu$ F and 0.1  $\mu$ F decoupling capacitors.

Before the IDAC0 output can be observed on TB1 with an oscilloscope, place a shorting block on J10 which connects P0.1/IDAC0 to a 1 k $\Omega$  resistor to ground.

Before the IDAC1 output can be observed on TB1 with an oscilloscope, place a shorting block on J11 which connects P1.2/IDAC1 to a 1 k $\Omega$  resistor to ground.

## 5.8. Port Pin Headers (J3-J5)

All of the MCU port pins are available on the 0.100 inch headers.

Shorting blocks are placed on J6 and J7, connecting pins P0.2 and P0.3 to the P0.2 and P0.3 headers on J3. Pin P0.2 and P0.3 can also connect to an external oscillator circuit. When using an external oscillator driver circuit, remove the shorting block on J6 and J7.

# C8051F39x/F37x

## 5.9. C8051F39x Board Default and Optional Connections

The C8051F39x MCU card has many default and optional connections for use with the UDP motherboard. The default connections have shorting jumpers consisting of a 402 resistor footprint with solder connecting the two pads. To disconnect a default connection, remove the solder between the pads. To reconnect, install a 0  $\Omega$  402 resistor or connect the two pads with solder. The optional connections are non-populated (no-pop) resistor footprints. To connect, install a 0  $\Omega$  402 resistor or connect the two pads with solder.

Table 1 shows a summary of the default and optional connections for each pin. Further explanation of the UDP motherboard signals can be found in Section 6.2.

**Table 1. MCU Pin Functions**

MCU Pin	MCU Card Function (via shorting blocks)		UDP Motherboard Signal (via 402 resistor footprint)	
	Default	Optional	Default	Optional
P0.0/VREF	VREF			
P0.1/IDAC0	IDAC0			
P0.2/XTAL1			EXT_INT0	
P0.3/XTAL2			EXT_INT1	
P0.4/TX	TX			
P0.5/RX	RX			
P0.6		CTS		
P0.7	Potentiometer	RTS		
P1.0				
P1.1			CLKOUT0/SYSCLK	
P1.2/IDAC1		IDAC1		
P1.3			PCA_CEX0, SPI_SL- CK_A	
P1.4			SPI_MISO_A, PCA_CEX1	
P1.5			PCA_CEX2, SPI_- MOSI_A	
P1.6			SPI_NSS0_A, PCA	
P1.7			SMBUS0_SDA, T0	
P2.0			SMBUS0_SCL, T1, ADC_IN0	
P2.1			CP_OUT_A, ADC_IN3	
P2.2			CP_OUT_A_A, ADC_IN2	
P2.3			ADC_IN1	SMBUS_SDA_EZR
P2.4				SMBUS_SCL_EZR

## 5.9.1. P0.2 and P0.3

By default, pins P0.2 and P0.3 connect to the EXT\_INT0 and EXT\_INT1 signals respectively on the UDP motherboard. To disconnect these signals, remove the solder on the R13 and R14 footprint resistors.

## 5.9.2. P1.1

By default, pin P1.1 connects to the CLKOUT0/SYSCLK signal on the UDP motherboard. To disconnect this signal, remove the solder on the R15 foot resistor.

## 5.9.3. P1.7 and 2.0

By default, pins P1.7 and P2.0 connect to the SMBUS0\_SDA and SMBUS0\_SCL signals respectively on the UDP motherboard. To disconnect these signals, remove the solder on the R24 and R26 footprint resistors.

By default, pins P1.7 and P2.0 also connect to the T0 and T1 signals respectively on the UDP motherboard. To disconnect these signals, remove the solder on the R25 and R27 footprint resistors.

By default, P2.0 also connects to the ADC\_IN0 signal on the UDP motherboard. To disconnect this signal, remove the solder on the R28 foot resistor.

## 5.9.4. P2.1 and R2.2

By default, pins P2.1 and P2.2 connect to the CP\_OUT\_A and CP\_OUT\_A\_A signals respectively on the UDP motherboard. To disconnect these signals, remove the solder on the R29 and R31 footprint resistors.

By default, pins P2.1 and P2.2 also connect to the ADC\_IN3 and ADC\_IN2 signals respectively on the UDP motherboard. To disconnect these signals, remove the solder on the R30 and R32 footprint resistors.

## 5.9.5. P2.3 and R2.4

By default, pins P2.2 and P2.4 do not connect to the SMBUS\_SDA\_EZR and SMBUS\_SCL\_EZR signals respectively on the UDP motherboard. To connect these signals, solder the R33 and R35 footprint resistors.

By default, pin P1.0 connects to the ADC\_IN1 signal on the UDP motherboard. To disconnect this signal, remove the solder on the R34 foot resistor.

## 6. Using the C8051F39x with the UDP Motherboard

### 6.1. VBAT Selector Switch

When used with the UDP motherboard, the motherboard can power the C8051F39x MCU card. With the VBAT selector switch in the VREG position, the motherboard powers the regulator on the card. With the VBAT selector switch in the UDP position, the UDP motherboard powers VBAT directly. This position supports software control of the variable voltage power supply and current measurements.

The S1 switch on the UDP motherboard selects between the fixed or programmable voltage. The variable supply is controlled by the C8051F384 board control MCU through the U1 digital potentiometer. Use the fixed supply when the variable supply is not under software control.

### 6.2. MCU Card Header Connections

The C8051F39x MCU card has four connectors with 100 pins each. These 400 pins are directly tied to the UDP motherboard and I/O cards. These signals are named and designed to support a wide variety of features and applications, and the UDP C8051F390/F370 MCU Card card implements a subset of these connections.

The MCU cards and I/O cards are designed so that a maximum number of functions are shared between each card. This allows a particular type of I/O card to be shared amongst all MCU cards that connect to the same signals.

The MCU card slot includes the following components:

- J1 MCU card connector H1
- J2 MCU card connector H2
- J3 MCU card connector H3
- J4 MCU card connector H4

The C8051F39x MCU card implements the signals described in Table 3, Table 4, Table 5, and Table 6 in the Appendix.

## 6.3. Shorting Blocks: Factory Defaults

The UDP C8051F390/F370 MCU Card comes from the factory with pre-installed shorting blocks on several headers. Figure 8 shows the positions of the factory default shorting blocks.

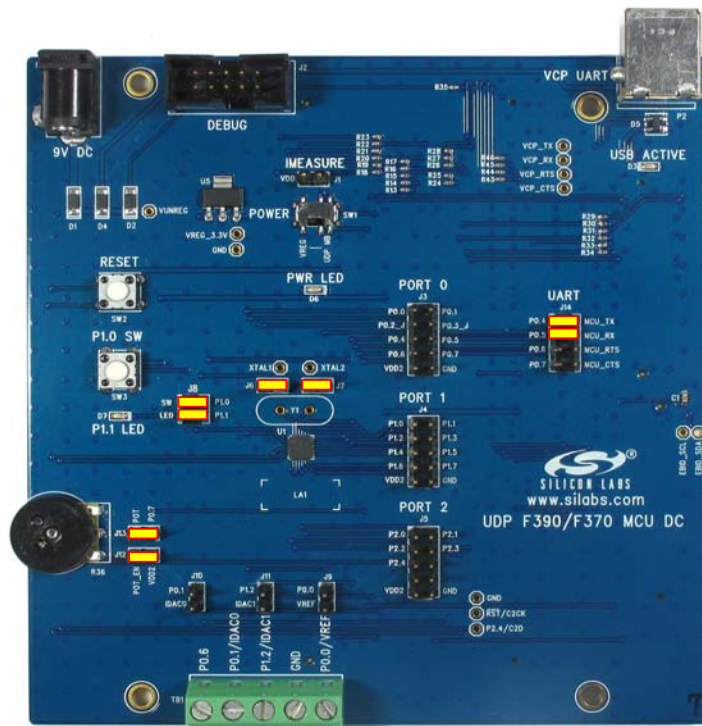

**Figure 8. Shorting Blocks: Factory Defaults**

Shorting blocks are installed on J14 to connect P0.4 to MCU\_TX and P0.5 to MCU\_RX.

## 7. Schematics

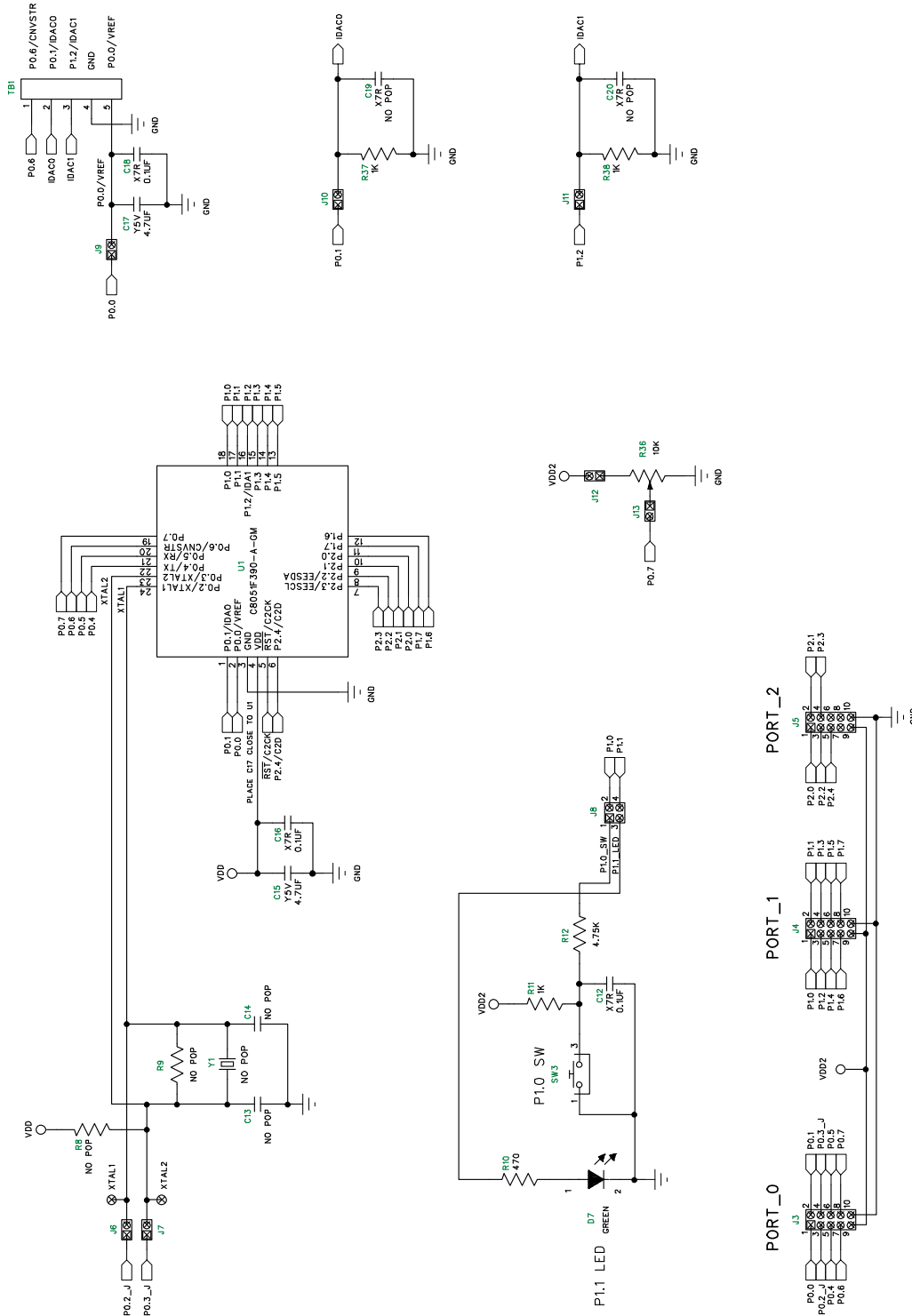

Figure 9. C8051F39x UDP MCU Card Schematic (1 of 6)



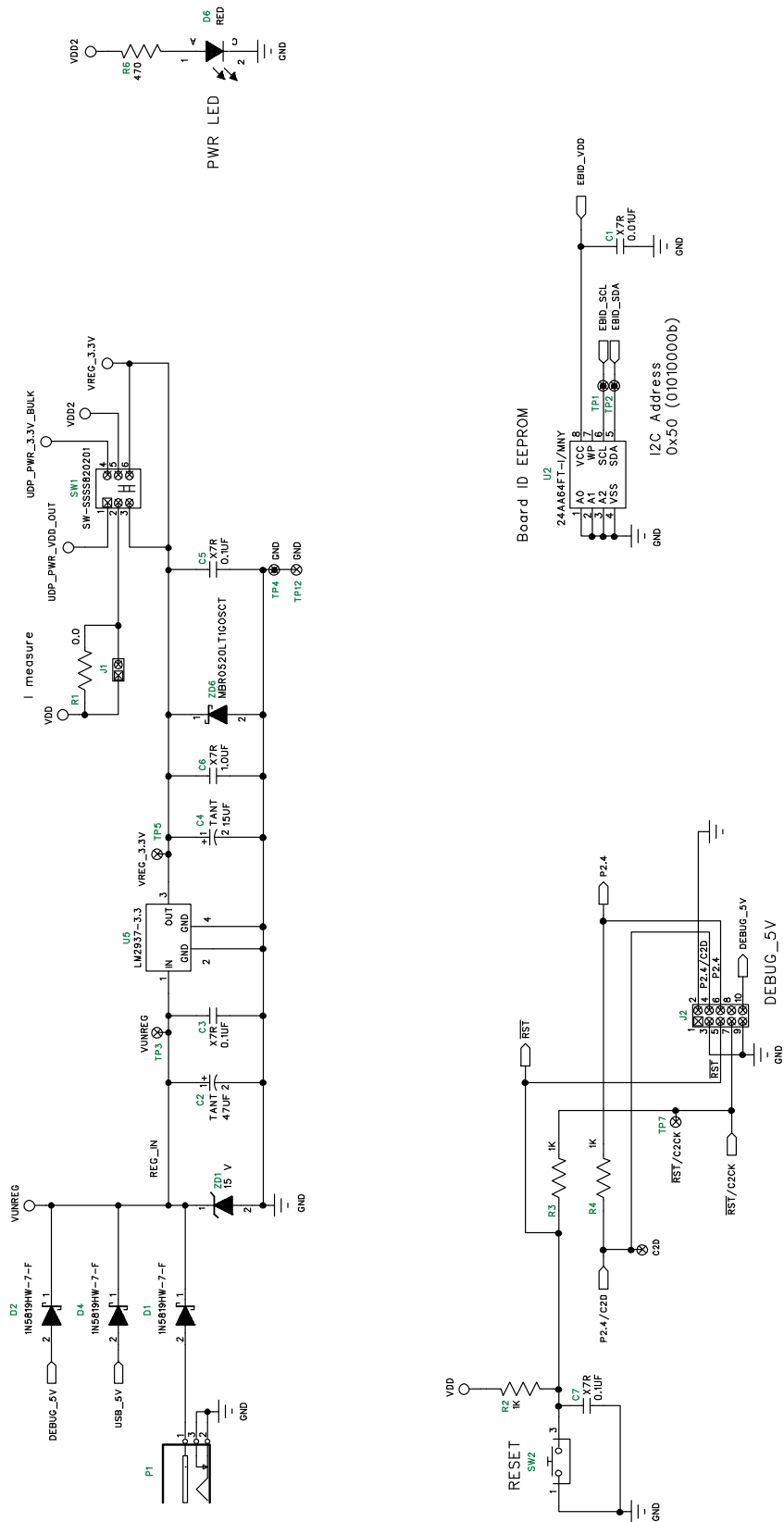
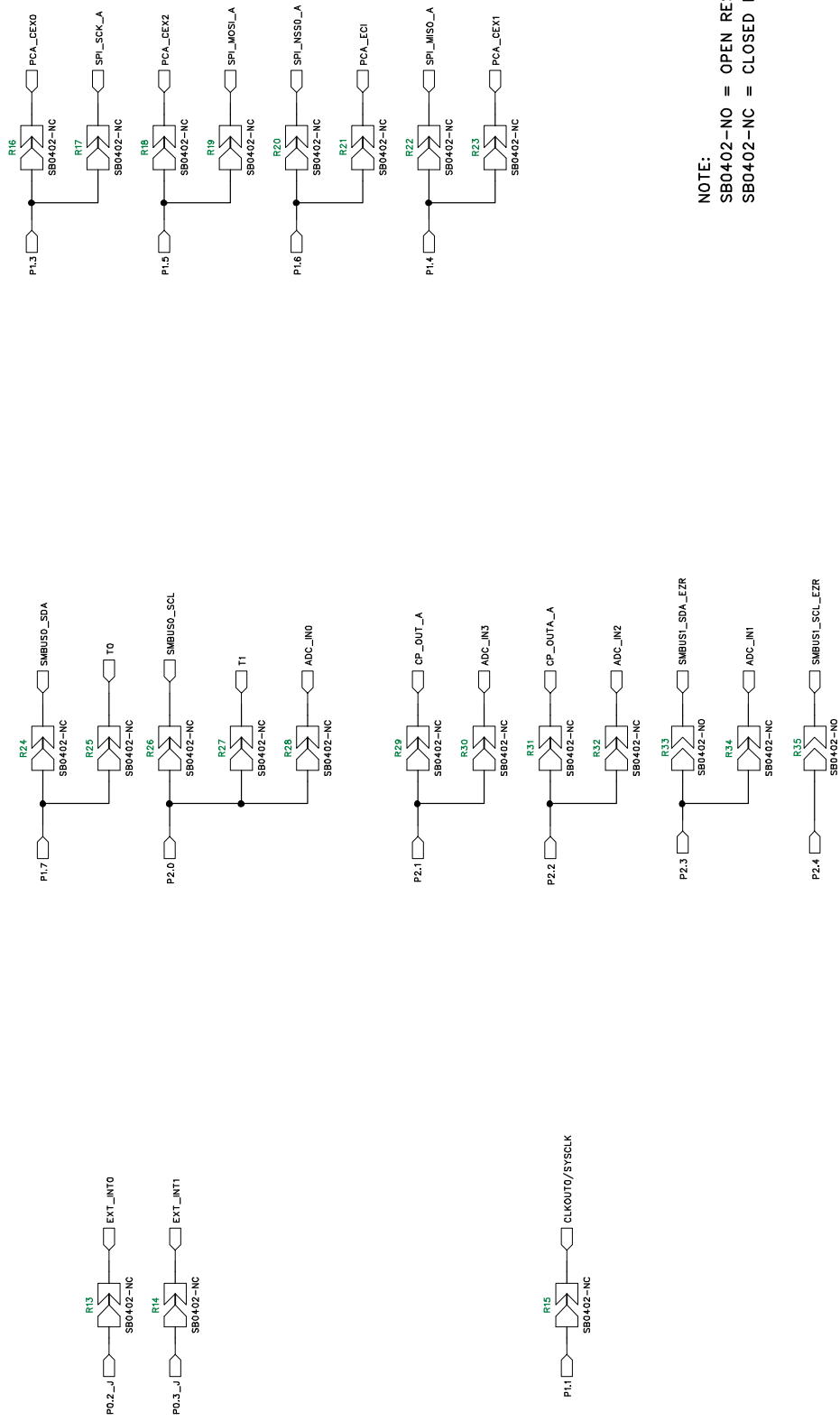
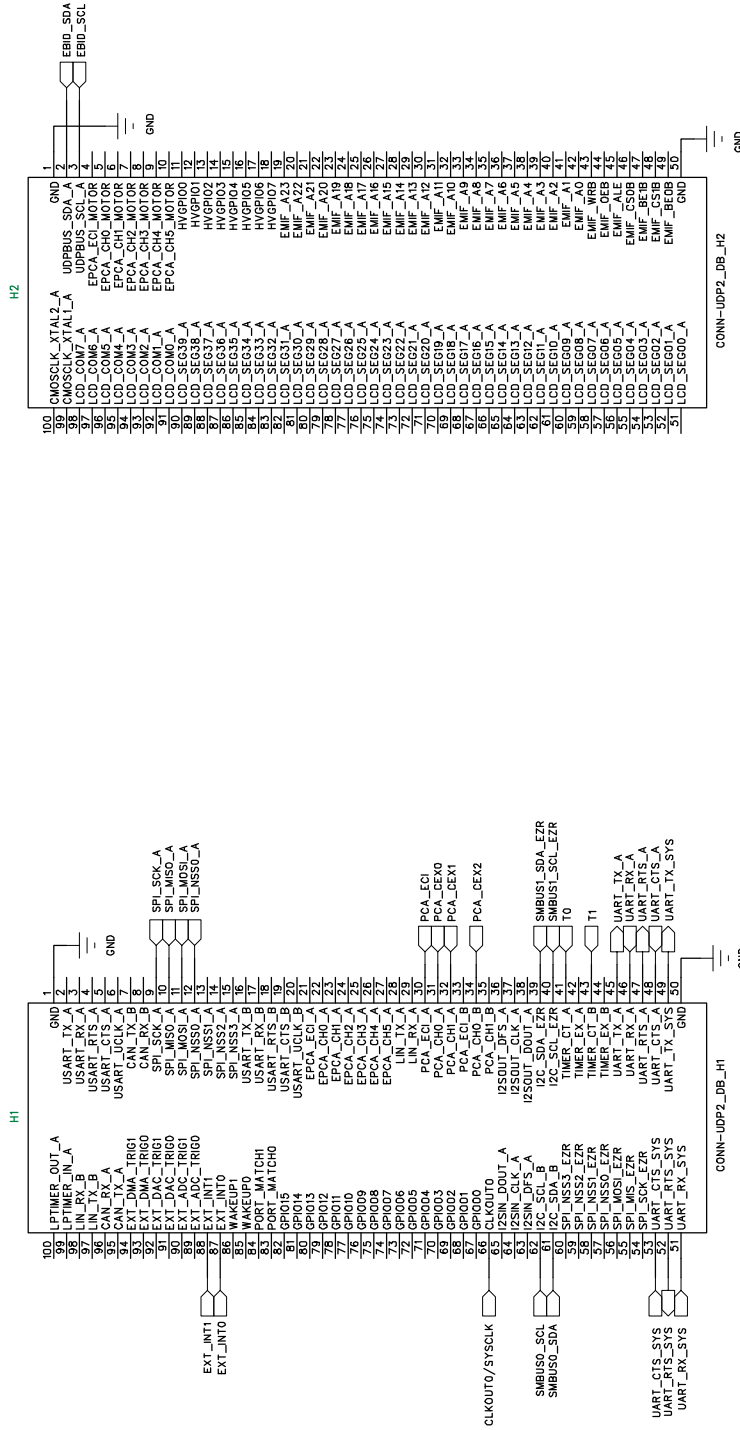

Figure 10. C8051F39x UDP MCU Card Schematic (2 of 6)



NOTE:  
 SBO402-NO = OPEN RESISTOR.  
 SBO402-NC = CLOSED RESISTOR.

Figure 11. C8051F39x UDP MCU Card Schematic (3 of 6)



UDP Header 1 (Top View)

UDP Header 2 (Top View)

Figure 12. C8051F39x UDP MCU Card Schematic (4 of 6)

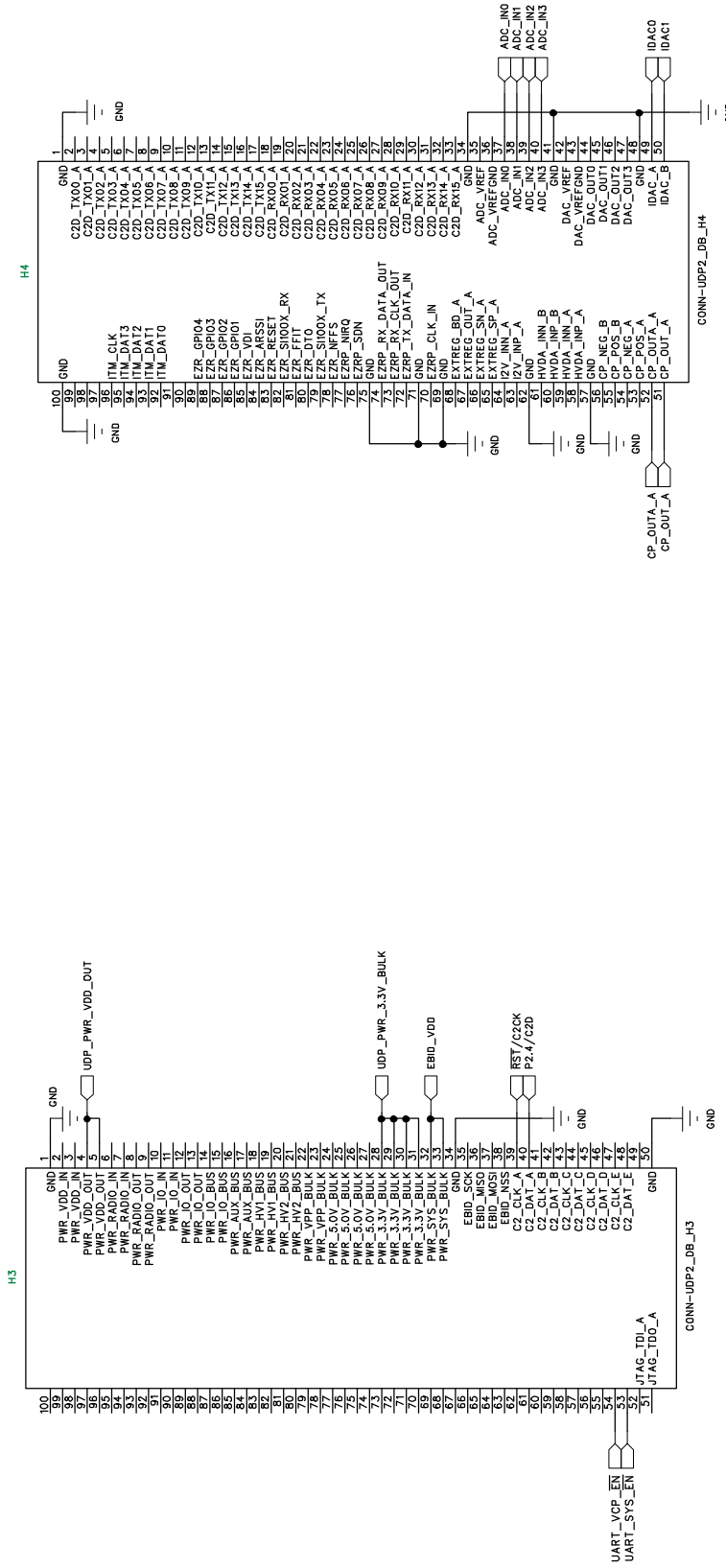

UDP Header 3 (Top View)

UDP Header 4 (Top View)

Figure 13. C8051F39x UDP MCU Card Schematic (5 of 6)

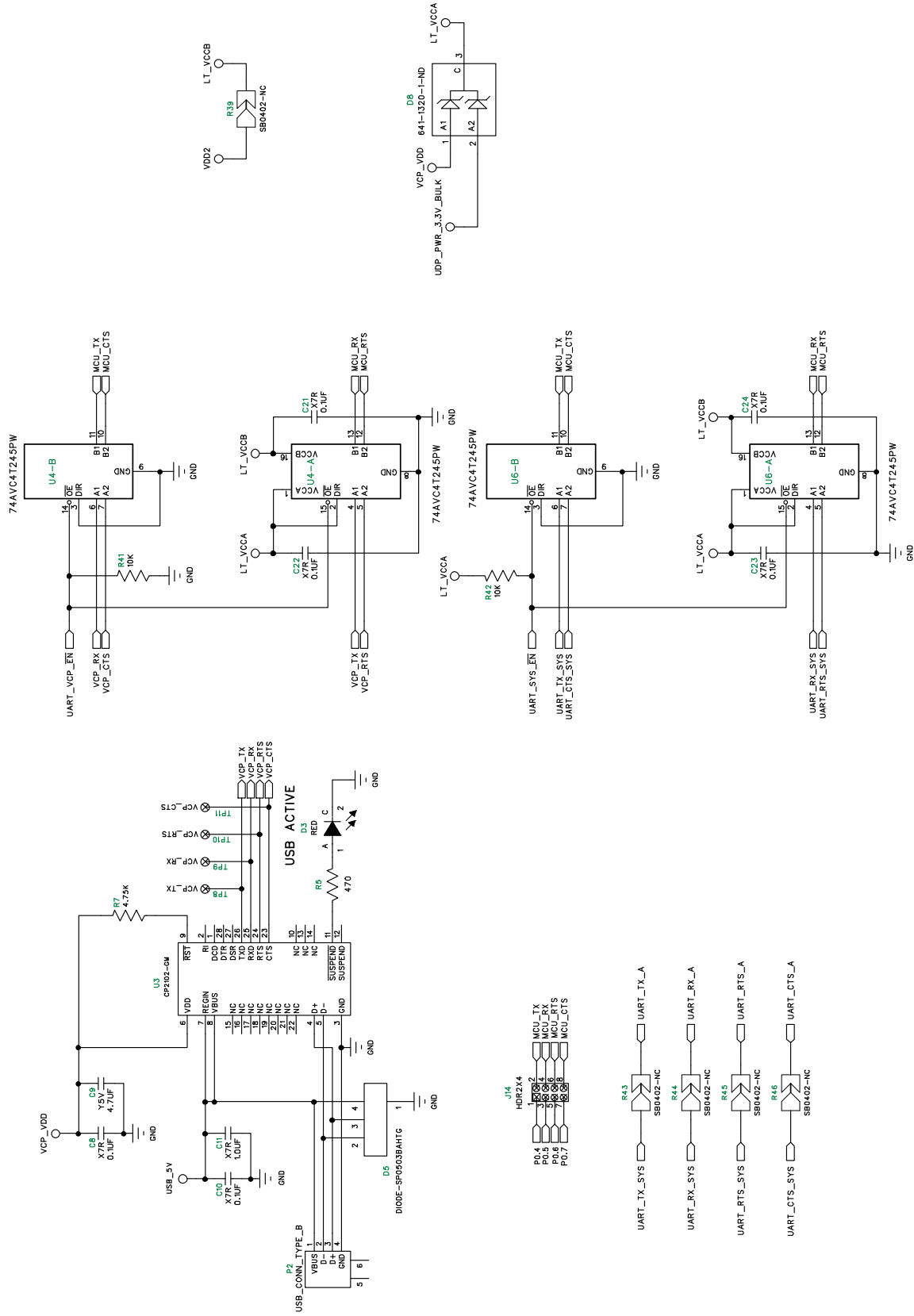

Figure 14. C8051F39x UDP MCU Card Schematic (6 of 6)

# C8051F39x/F37x

## 8. Bill of Materials

**Table 2. UPMU-F390-A/UPMU-F370-A Bill of Materials**

Reference	Part Number	Source	Description
U1	C8051F390-A-GM or C8501F370-A-GM	Silicon Labs	Mixed-Signal MCU, 50 MIPS 16 kB Flash, 512B EEPROM, RoHS.
U3	CP2102-GM	Silicon Labs	SINGLE-CHIP USB TO UART BRIDGE, QFN28, RoHS.
U2	24AA64FT-I/MNY	Microchip	64KBIT I <sup>2</sup> C SERIAL FLASH, 400 KHZ, 8- TDFN, RoHS.
U4 U6	SN74AVC4T245PWR	Texas Instruments	Quad Dual-Supply Level Shifter, TSSOP
C1	06035C103KAT2A	AVX Corporation	CAP, 0.01 $\mu$ F (10000PF), X7R, CERAMIC, 0603, 50 V, $\pm$ 10%, OR EQ, RoHS.
C3 C5 C7-8 C10 C12 C16 C18 C21-24	C0603C104J3RACTU	Kemet	CAP, 0.1 $\mu$ F, X7R, CERAMIC, 0603, 25 V, $\pm$ 5%, OR EQ, RoHS.
C6 C11	GRM188R71A105KA61D	Murata	CAP CERAMIC, 1.0 $\mu$ F, X5R, 0603, 10 V, $\pm$ 10%, RoHS.
C4	TCA1A156M8R	Rohm	CAP TANT, 15 $\mu$ F, A-CASE, 10 V, $\pm$ 20%, OR EQ, RoHS.
C9 C15 C17	GRM188F51A475ZE20D	Murata	CAP, 4.7 $\mu$ F, Y5V, CERAMIC, 0603, 10 V, -20%, +80%, OR EQ, RoHS.
C2	TAJ476K016RNJ	AVX Corporation	CAP, 47 $\mu$ F, TANT, 6032-28, 16 V, $\pm$ 10%, OR EQ, RoHS.
C13-14 C19- 20	NO POP	NO POP	CAP, NO POP, 0603, OR EQ, RoHS.
P1	RAPC722X	Switchcraft Inc.	CONN, POWERJACK MINI.08" RA PC MNT, RoHS.
H1 H2 H3 H4	FX8-100P-SV1(91)	Hirose Electronic Co Ltd	CONN, HDR, 100POS, .6 mm, GOLD, SMD, RoHS
D1-2 D4	1N5819HW-7-F	Diodes Inc	DIODE SCHOTTKY, 40 V, 1A, SOD123, RoHS.
D8	BAT54C-G	Comchip Technology	DIODE, Schottkey DUAL CC, 200 mA, 30 V, SOT23,RoHS.
ZD6	MBR0520LT1G	ON Semiconductor	DIODE SCHOTTKY 0.5A 20 V, SOD123, RoHS.
ZD1	MMSZ5245B-7-F	Diodes Inc	DIODE, ZENER, 15 V, 500MW, SMT, SOD123, RoHS.

**Table 2. UPMU-F390-A/UPMU-F370-A Bill of Materials (Continued)**

Reference	Part Number	Source	Description
D5	SP0503BAHTG	Littelfuse Inc	TVS AVAL DIODE ARRAY, 3 CH, SOT143, RoHS.
J1 J6-7 J9-13	PBC02SAAN	Sullens Connector Solutions	STAKE HEADER, 1X2, 0.1"CTR, GOLD, OR EQ, RoHS.
J8	PBC02DAAN	Sullens Connector Solutions	STAKE HEADER, 2x2, 0.1"CTR, GOLD, OR EQ, RoHS.
J14	PBC04DAAN	Sullens Connector Solutions	STAKE HEADER, 2x4, 0.1"CTR, OR EQ, RoHS.
J3-5	PBC05DAAN	Sullens Connector Solutions	STAKE HEADER, 2x5, 0.1"CTR, GOLD, OR EQ, RoHS.
J2	N2510-6002-RB	3M	HEADER, SHROUDED, 2x5, OR EQ, RoHS.
D7	SML-LX0603GW-TR	Lumex Opto/Components Inc	LED, 565NM, GREEN DIFF, SMT0603, OR EQ, RoHS.
D3 D6	SML-LX0603IW-TR	Lumex Opto/Components Inc	LED, RED DIFF, 635NM, SMT0603, OR EQ, RoHS.
U5	LM2937IMP-3.3/NOPB	National Semiconductor	VOLTAGE REG, 3.3 V, LDO, 500MA, SOT223, RoHS.
R36	RV100F-30-4K1B-B10K-B301	Alpha (Taiwan)	POT, 10K, THUMBWHEEL LINEAR, 0.03W, ±20%, OR EQ, RoHS.
R1	RC0603JR-070RL	Yageo	RES, 0.0, SMT, 0603, 1/10W, ±5%, OR EQ, RoHS.
R41-42	ERJ-3EKF1002V	Panasonic Electronic Components	RES, EQ. 10.0 kΩ, SMT, 0603, 1/10W, ±1%, OR EQ, RoHS.
R2-4 R11 R37-38	ERJ-3EKF1001V	Panasonic Electronic Components	RES, 1 kΩ, SMT, 0603, 1/10W, ±1%, OR EQ, RoHS.
R7 R12	ERJ-3EKF4751V	Panasonic Electronic Components	RES, 4.75 kΩ, SMT, 0603, 1/10W, ±1%, OR EQ, RoHS.
R5-6 R10	MCR03EZPJ471	Rohm Semiconductor	RES, 470 Ω, SMT, 0603, 1/10W, ±5%, OR EQ, RoHS.
R8-9	NO POP	NO POP	RES, NO POP, SMT, 0603, OR EQ, RoHS.
R13-32 R34 R39 R43-46	N/A	N/A	SOLDER BUMP RESISTOR, CLOSED, 0402, RoHS.
R33 R35	N/A	N/A	SOLDER BUMP RESISTOR, OPEN, 0402, RoHS.
SJ1-6	SPC02SYAN	Sullins Connector Solutions	CONN, JUMPER SHORTING, TIN, OR EQ, RoHS.

# C8051F39x/F37x

---

**Table 2. UPMU-F390-A/UPMU-F370-A Bill of Materials (Continued)**

<b>Reference</b>	<b>Part Number</b>	<b>Source</b>	<b>Description</b>
SW2-3	EVQ-PAD04M	Panasonic Electronic Components	SWITCH, LIGHT TOUCH, 130GF, 6 mm SQ, RoHS.
SW1	SSSS820201	Alps	SWITCH SLIDE, SMT, RoHS.
TP1-12 TP42-43	NO POP	NO POP	TEST POINT, PC COMPACT, NO POP, OR EQ, RoHS.
TB1	1729157	Phoenix Contact	TERM. BLOCK, 5.08 mm CTRS, 5 POS, RoHS.
P2	61729-0010BLF	FCI	CONN, USB RECEPT, TYPE B, RoHS.
Y1	NO POP	NO POP	CRYSTAL, NO POP, OR EQ, RoHS.



## APPENDIX—MCU CARD HEADER PIN DESCRIPTIONS

Table 3. UDP C8051F390/F370 MCU Card H1 Pin Descriptions

MCU Card Pin	Signal Name	Usage
1	GND	
2	USART_TX_A	
3	USART_RX_A	
4	USART_RTS_A	
5	USART_CTS_A	
6	USART_UCLK_A	
7	CAN_TX_B	
8	CAN_RX_B	
9	SPI_SCK_A	SPI0 clock
10	SPI_MISO_A	SPI0 master-in, slave-out
11	SPI_MOSI_A	SPI0 master-out, slave-in
12	SPI_NSS0_A	SPI0 slave select
13	SPI_NSS1_A	
14	SPI_NSS2_A	
15	SPI_NSS3_A	
16	USART_TX_B	
17	USART_RX_B	
18	USART_RTS_B	
19	USART_CTS_B	
20	USART_UCLK_B	
21	EPCA_ECI_A	
22	EPCA_CH0_A	
23	EPCA_CH1_A	
24	EPCA_CH2_A	
25	EPCA_CH3_A	
26	EPCA_CH4_A	
27	EPCA_CH5_A	
28	LIN_TX_A	
29	LIN_RX_A	
30	PCA_ECI_A	PCA0 external clock input
31	PCA_CH0_A	PCA0 channel 0
32	PCA_CH1_A	PCA0 channel 1
33	PCA_ECI_B	
34	PCA_CH0_B	PCA0 channel 2
35	PCA_CH1_B	
36	I2SOUT_DFS_A	

**Table 3. UDP C8051F390/F370 MCU Card H1 Pin Descriptions (Continued)**

MCU Card Pin	Signal Name	Usage
37	I2SOUT_CLK_A	
38	I2SOUT_DOUT_A	
39	I2C_SDA_EZR	EZRadioPro I <sup>2</sup> C data
40	I2C_SCL_EZR	EZRadioPro I <sup>2</sup> C clock
41	TIMER_CT_A	Timer0 input
42	TIMER_EX_A	
43	TIMER_CT_B	Timer1 input
44	TIMER_EX_B	
45	UART_TX_A	UART A transmit
46	UART_RX_A	UART A receive
47	UART_RTS_A	UART A hardware handshaking
48	UART_CTS_A	UART A hardware handshaking
49	UART_TX_SYS	System UART transmit
50	GND	
51	UART_RX_SYS	System UART receive
52	UART_RTS_SYS	System UART hardware handshaking
53	UART_CTS_SYS	System UART hardware handshaking
54	SPI_SCK_EZR	
55	SPI_MISO_EZR	
56	SPI_MOSI_EZR	
57	SPI_NSS0_EZR	
58	SPI_NSS1_EZR	
59	SPI_NSS2_EZR	
60	SPI_NSS3_EZR	
61	I2C_SDA_B	SMBUS0 data
62	I2C_SCL_B	SMBUS0 clock
63	I2SIN_DFS_A	
64	I2SIN_CLK_A	
65	I2SIN_DOUT_A	
66	CLKOUT0	MCU system clock
67	GPIO00	
68	GPIO01	
69	GPIO02	
70	GPIO03	
71	GPIO04	
72	GPIO05	
73	GPIO06	

**Table 3. UDP C8051F390/F370 MCU Card H1 Pin Descriptions (Continued)**

MCU Card Pin	Signal Name	Usage
74	GPIO07	
75	GPIO08	
76	GPIO09	
77	GPIO10	
78	GPIO11	
79	GPIO12	
80	GPIO13	
81	GPIO14	
82	GPIO15	
83	PORT_MATCH0	
84	PORT_MATCH1	
85	WAKEUP0	
86	WAKEUP1	
87	EXT_INT0	External interrupt 0
88	EXT_INT1	External interrupt 1
89	EXT_ADC_TRIG0	
90	EXT_ADC_TRIG1	
91	EXT_DAC_TRIG0	
92	EXT_DAC_TRIG1	
93	EXT_DMA_TRIG0	
94	EXT_DMA_TRIG1	
95	CAN_TX_A	
96	CAN_RX_A	
97	LIN_TX_B	
98	LIN_RX_B	
99	LPTIMER_IN_A	
100	LPTIMER_OUT_A	

**Table 4. UDP C8051F390/F370 MCU Card H2 Pin Descriptions**

MCU Card Pin	Signal Name	Description
1	GND	
2	UDPBUS_SDA_A	Electronic Board ID I <sup>2</sup> C data
3	UDPBUS_SCL_A	Electronic Board ID I2C clock
4	EPCA_ECI_MOTOR	
5	EPCA_CH0_MOTOR	
6	EPCA_CH1_MOTOR	
7	EPCA_CH2_MOTOR	
8	EPCA_CH3_MOTOR	
9	EPCA_CH4_MOTOR	
10	EPCA_CH5_MOTOR	
11	HVGPI00	
12	HVGPI01	
13	HVGPI02	
14	HVGPI03	
15	HVGPI04	
16	HVGPI05	
17	HVGPI06	
18	HVGPI07	
19	EMIF_A23	
20	EMIF_A22	
21	EMIF_A21	
22	EMIF_A20	
23	EMIF_A19	
24	EMIF_A18	
25	EMIF_A17	
26	EMIF_A16	
27	EMIF_A15	
28	EMIF_A14	
29	EMIF_A13	
30	EMIF_A12	
31	EMIF_A11	
32	EMIF_A10	
33	EMIF_A9	
34	EMIF_A8	
35	EMIF_A7	
36	EMIF_A6	
37	EMIF_A5	

**Table 4. UDP C8051F390/F370 MCU Card H2 Pin Descriptions (Continued)**

MCU Card Pin	Signal Name	Description
38	EMIF_A4	
39	EMIF_A3	
40	EMIF_A2	
41	EMIF_A1	
42	EMIF_A0	
43	EMIF_WRB	
44	EMIF_OEB	
45	EMIF_ALE	
46	EMIF_CS0B	
47	EMIF_BE1B	
48	EMIF_CS1B	
49	EMIF_BE0B	
50	GND	
51	LCD_SEG00_A	
52	LCD_SEG01_A	
53	LCD_SEG02_A	
54	LCD_SEG03_A	
55	LCD_SEG04_A	
56	LCD_SEG05_A	
57	LCD_SEG06_A	
58	LCD_SEG07_A	
59	LCD_SEG08_A	
60	LCD_SEG09_A	
61	LCD_SEG10_A	
62	LCD_SEG11_A	
63	LCD_SEG12_A	
64	LCD_SEG13_A	
65	LCD_SEG14_A	
66	LCD_SEG15_A	
67	LCD_SEG16_A	
68	LCD_SEG17_A	
69	LCD_SEG18_A	
70	LCD_SEG19_A	
71	LCD_SEG20_A	
72	LCD_SEG21_A	
73	LCD_SEG22_A	
74	LCD_SEG23_A	

Table 4. UDP C8051F390/F370 MCU Card H2 Pin Descriptions (Continued)

MCU Card Pin	Signal Name	Description
75	LCD_SEG24_A	
76	LCD_SEG25_A	
77	LCD_SEG26_A	
78	LCD_SEG27_A	
79	LCD_SEG28_A	
80	LCD_SEG29_A	
81	LCD_SEG30_A	
82	LCD_SEG31_A	
83	LCD_SEG32_A	
84	LCD_SEG33_A	
85	LCD_SEG34_A	
86	LCD_SEG35_A	
87	LCD_SEG36_A	
88	LCD_SEG37_A	
89	LCD_SEG38_A	
90	LCD_SEG39_A	
91	LCD_COM0_A	
92	LCD_COM1_A	
93	LCD_COM2_A	
94	LCD_COM3_A	
95	LCD_COM4_A	
96	LCD_COM5_A	
97	LCD_COM6_A	
98	LCD_COM7_A	
99	CMOSCLK_XTAL1_A	
100	CMOSCLK_XTAL2_A	

**Table 5. UDP C8051F390/F370 MCU Card H3 Pin Descriptions**

MCU Card Pin	Description	Description
1	GND	
2	PWR_VDD_IN	
3	PWR_VDD_IN	
4	PWR_VDD_OUT	Programmable Supply from UDP to VDD (when VDD select switch is set to UDP)
5	PWR_VDD_OUT	
6	PWR_RADIO_IN	
7	PWR_RADIO_IN	
8	PWR_RADIO_OUT	
9	PWR_RADIO_OUT	
10	PWR_IO_IN	
11	PWR_IO_IN	
12	PWR_IO_OUT	
13	PWR_IO_OUT	
14	PWR_IO_BUS	
15	PWR_IO_BUS	
16	PWR_AUX_BUS	
17	PWR_AUX_BUS	
18	PWR_HV1_BUS	
19	PWR_HV1_BUS	
20	PWR_HV2_BUS	
21	PWR_HV2_BUS	
22	PWR_VPP_BULK	
23	PWR_VPP_BULK	
24	PWR_5.0_BULK	
25	PWR_5.0_BULK	
26	PWR_5.0_BULK	
27	PWR_5.0_BULK	
28	PWR_3.3_BULK	3.3 V power from the UDP mother (Powers VDD2 when VDD select switch is set to UDP)
29	PWR_3.3_BULK	
30	PWR_3.3_BULK	
31	PWR_3.3_BULK	
32	PWR_SYS_BULK	3.3 V power supply for EBID EEPROM
33	PWR_SYS_BULK	
34	GND	
35	EBID_SCK	
36	EBID_MOSI	
37	EBID_MISO	

# C8051F39x/F37x

**Table 5. UDP C8051F390/F370 MCU Card H3 Pin Descriptions (Continued)**

MCU Card Pin	Description	Description
38	EBID_NSS	
39	C2_CLK_A	Reset/C2 interface clock
40	C2_DAT_A	P2.4/C2 interface data
41	C2_CLK_B	
42	C2_DAT_B	
43	C2_CLK_C	
44	C2_DAT_C	
45	C2_CLK_D	
46	C2_DAT_D	
47	C2_CLK_E	
48	C2_DAT_E	
49	nc	
50	GND	
51	JTAG_TDO_A	
52	JTAG_TDI_A	
53	VCP_EN	Active-low enable for MCU Card VCP Bridge (default)
54	UART_SYS_EN	Active-low enable for MCU to UDP UART path
55	H3_55	
56	H3_56	
57	H3_57	
58	H3_58	
59	H3_59	
60	H3_60	
61	H3_61	
62	H3_62	
63	H3_63	
64	H3_64	
65	H3_65	
66	H3_66	
67	H3_67	
68	H3_68	
69	H3_69	
70	H3_70	
71	H3_71	
72	H3_72	
73	H3_73	
74	H3_74	



**Table 5. UDP C8051F390/F370 MCU Card H3 Pin Descriptions (Continued)**

<b>MCU Card Pin</b>	<b>Description</b>	<b>Description</b>
75	H3_75	
76	H3_76	
77	H3_77	
78	H3_78	
79	H3_79	
80	H3_80	
81	H3_81	
82	H3_82	
83	H3_83	
84	H3_84	
85	H3_85	
86	H3_86	
87	H3_87	
88	H3_88	
89	H3_89	
90	H3_90	
91	H3_91	
92	H3_92	
93	H3_93	
94	H3_94	
95	H3_95	
96	H3_96	
97	H3_97	
98	H3_98	
99	H3_99	
100	H3_100	

**Table 6. UDP C8051F390/F370 MCU Card H4 Pin Descriptions**

MCU Card Pin	Description	Description
1	GND	
2	C2D_TX00_A	
3	C2D_TX01_A	
4	C2D_TX02_A	
5	C2D_TX03_A	
6	C2D_TX04_A	
7	C2D_TX05_A	
8	C2D_TX06_A	
9	C2D_TX07_A	
10	C2D_TX08_A	
11	C2D_TX09_A	
12	C2D_TX10_A	
13	C2D_TX11_A	
14	C2D_TX12_A	
15	C2D_TX13_A	
16	C2D_TX14_A	
17	C2D_TX15_A	
18	C2D_RX00_A	
19	C2D_RX01_A	
20	C2D_RX02_A	
21	C2D_RX03_A	
22	C2D_RX04_A	
23	C2D_RX05_A	
24	C2D_RX06_A	
25	C2D_RX07_A	
26	C2D_RX08_A	
27	C2D_RX09_A	
28	C2D_RX10_A	
29	C2D_RX11_A	
30	C2D_RX12_A	
31	C2D_RX13_A	
32	C2D_RX14_A	
33	C2D_RX15_A	
34	GND	
35	ADC_VREF	
36	ADC_VREFGND	
37	ADC_IN0	ADC0 input 0

**Table 6. UDP C8051F390/F370 MCU Card H4 Pin Descriptions (Continued)**

MCU Card Pin	Description	Description
38	ADC_IN1	ADC0 input 1
39	ADC_IN2	ADC0 input 2
40	ADC_IN3	ADC0 input 3
41	GND	
42	DAC_VREF	
43	DAC_VREFGND	
44	DAC_OUT0	
45	DAC_OUT1	
46	DAC_OUT2	
47	DAC_OUT3	
48	GND	
49	IDAC_A	IDAC0 output
50	IDAC_B	IDAC1 output
51	CP_OUT_A	Comparator0 synchronous output
52	CP_OUTA_A	Comparator0 asynchronous output
53	CP_POS_A	
54	CP_NEG_A	
55	CP_POS_B	
56	CP_NEG_B	
57	GND	
58	HVDA_INP_A	
59	HVDA_INN_A	
60	HVDA_INP_B	
61	HVDA_INN_B	
62	GND	
63	I2V_INP_A	
64	I2V_INN_A	
65	EXTREG_SP_A	
66	EXTREG_SN_A	
67	EXTREG_OUT_A	
68	EXTREG_BD_A	
69	GND	
70	EZRP_CLK_IN	
71	GND	
72	EZRP_TX_DATA_IN	
73	EZRO_RX_CLK_OUT	
74	EZRP_RX_DATA_OUT	

Table 6. UDP C8051F390/F370 MCU Card H4 Pin Descriptions (Continued)

MCU Card Pin	Description	Description
75	GND	
76	EZRP_SDN	
77	EZRP_NIRQ	
78	EZR_NFFS	
79	EZR_SI100X_TX	
80	EZR_DTO	
81	EZR_FFIT	
82	EZR_SI100X_RX	
83	EZR_RESET	
84	EZR_ARSSI	
85	EZR_VDI	
86	EZR_GPIO0	
87	EZR_GPIO1	
88	EZR_GPIO2	
89	EZR_GPIO3	
90	EZR_GPIO4	
91	H4_91	
92	ITM_DAT0	
93	ITM_DAT1	
94	ITM_DAT2	
95	ITM_DAT3	
96	ITM_CLK	
97	H4_97	
98	H4_98	
99	H4_99	
100	GND	

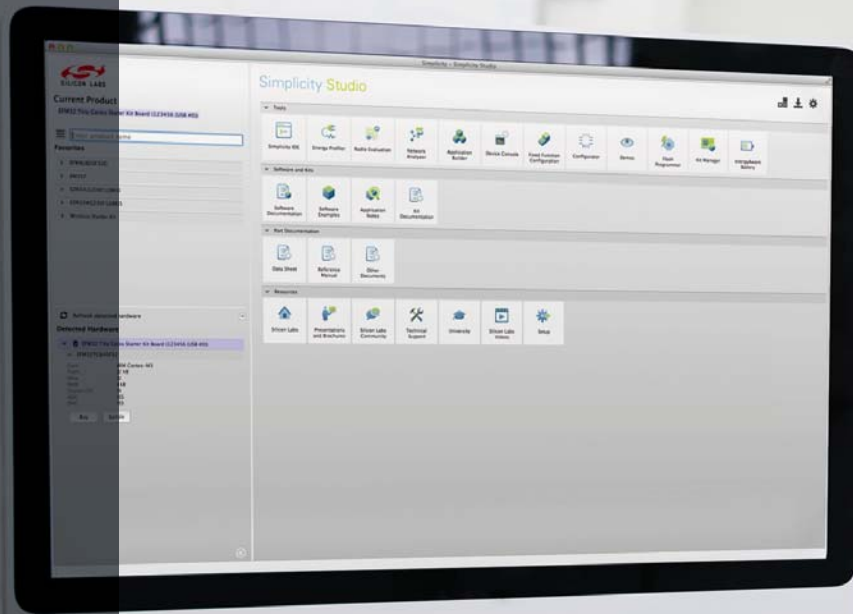

## Simplicity Studio

One-click access to MCU and wireless tools, documentation, software, source code libraries & more. Available for Windows, Mac and Linux!



**IoT Portfolio**  
[www.silabs.com/IoT](http://www.silabs.com/IoT)



**SW/HW**  
[www.silabs.com/simplicity](http://www.silabs.com/simplicity)



**Quality**  
[www.silabs.com/quality](http://www.silabs.com/quality)



**Support and Community**  
[community.silabs.com](http://community.silabs.com)

### Disclaimer

Silicon Laboratories intends to provide customers with the latest, accurate, and in-depth documentation of all peripherals and modules available for system and software implementers using or intending to use the Silicon Laboratories products. Characterization data, available modules and peripherals, memory sizes and memory addresses refer to each specific device, and "Typical" parameters provided can and do vary in different applications. Application examples described herein are for illustrative purposes only. Silicon Laboratories reserves the right to make changes without further notice and limitation to product information, specifications, and descriptions herein, and does not give warranties as to the accuracy or completeness of the included information. Silicon Laboratories shall have no liability for the consequences of use of the information supplied herein. This document does not imply or express copyright licenses granted hereunder to design or fabricate any integrated circuits. The products must not be used within any Life Support System without the specific written consent of Silicon Laboratories. A "Life Support System" is any product or system intended to support or sustain life and/or health, which, if it fails, can be reasonably expected to result in significant personal injury or death. Silicon Laboratories products are generally not intended for military applications. Silicon Laboratories products shall under no circumstances be used in weapons of mass destruction including (but not limited to) nuclear, biological or chemical weapons, or missiles capable of delivering such weapons.

### Trademark Information

Silicon Laboratories Inc., Silicon Laboratories, Silicon Labs, SiLabs and the Silicon Labs logo, CMEMS®, EFM, EFM32, EFR, Energy Micro, Energy Micro logo and combinations thereof, "the world's most energy friendly microcontrollers", Ember®, EZLink®, EZMac®, EZRadio®, EZRadioPRO®, DSPLL®, ISOModem®, Precision32®, ProSLIC®, SiPHY®, USBXpress® and others are trademarks or registered trademarks of Silicon Laboratories Inc. ARM, CORTEX, Cortex-M3 and THUMB are trademarks or registered trademarks of ARM Holdings. Keil is a registered trademark of ARM Limited. All other products or brand names mentioned herein are trademarks of their respective holders.



**SILICON LABS**

Silicon Laboratories Inc.  
 400 West Cesar Chavez  
 Austin, TX 78701  
 USA

<http://www.silabs.com>