

## EProClock® Generator

### Features

- PCI-Express Gen 2 Compliant
- Low power push-pull type differential output buffers
- Integrated resistors on all differential outputs
- Dedicated Output Enable pin for all outputs
- Dedicated SRC Bank Enable HW pin
- Scalable VDD\_IO support 1.05V to 3.3V
- Five 100MHz Differential PCIe Gen 2 clocks
- Two Configurable Single-Ended Clocks
- Three Buffered Reference Clock 25MHz
- 25MHz Crystal Input or Clock input
- EProClock® Programmable Technology
- I<sup>2</sup>C support with readback capabilities
- Triangular Spread Spectrum profile for maximum electromagnetic interference (EMI) reduction
- 3.3V Power supply
- 48-pin QFN package

SRC	25M	CONF_SE1	CONF_SE2
x5	x3	x1	x1

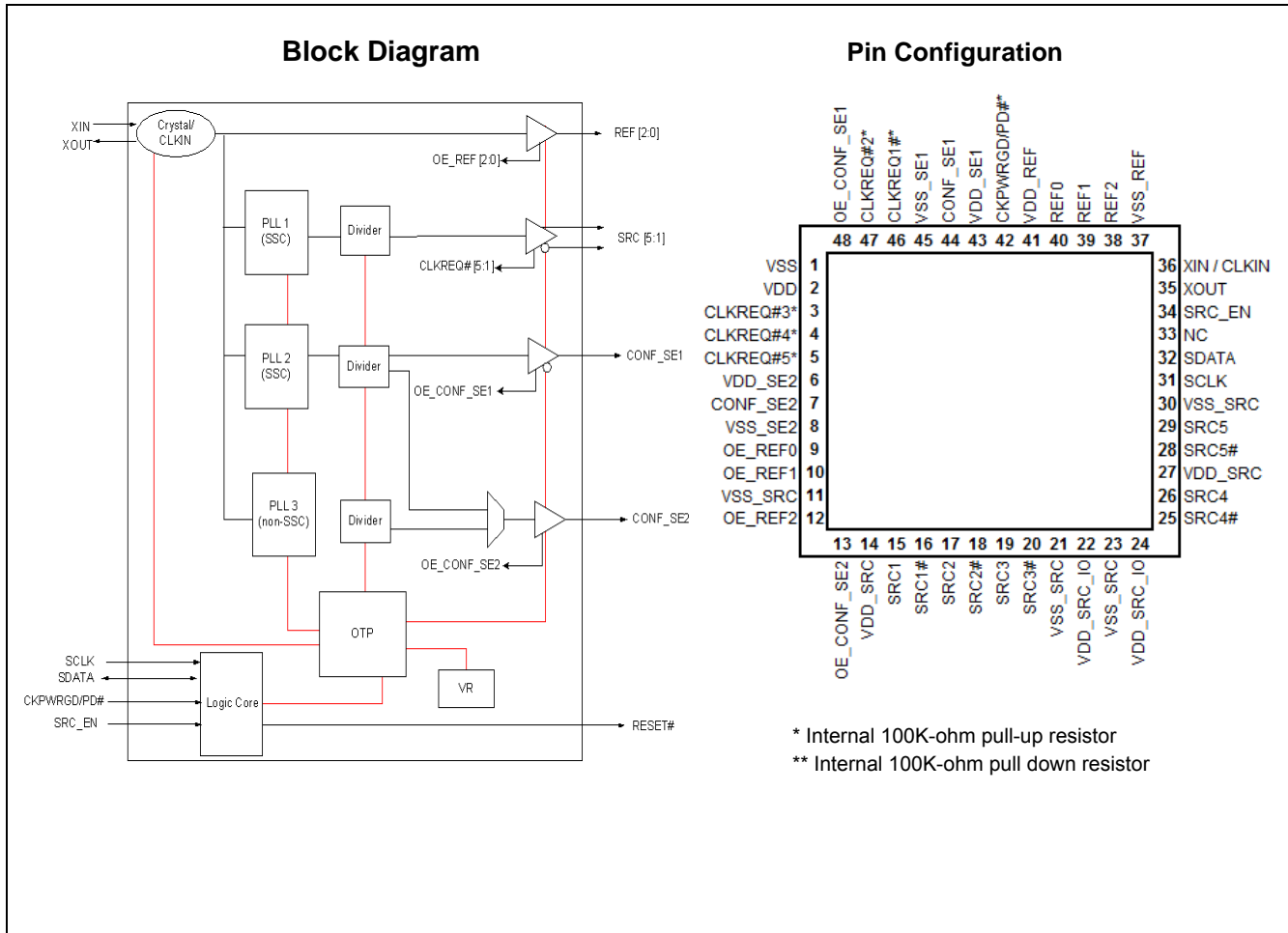

**32-QFN Pin Definitions**

Pin No.	Name	Type	Description
1	VSS_PCI	GND	Ground for PCI clock
2	VDD_PCI	PWR	3.3V, Power Supply for PCI clock
3	CLKREQ#3*	I, PU	3.3V, active low input clock request to enable SRC3 <i>(internal 100k-ohm internal pull-up)</i>
4	CLKREQ#4*	I, PU	3.3V, active low input clock request to enable SRC4 <i>(internal 100k-ohm internal pull-up)</i>
5	CLKREQ#5*	I, PU	3.3V, active low input clock request to enable SRC5 <i>(internal 100k-ohm internal pull-up)</i>
6	VDD_SE2	PWR	3.3V, Power Supply for CONF_SE2 clock
7	CONF_SE2	O, SE	3.3V, configurable single-ended clock
8	VSS_SE2	GND	Ground for SE2 clock
9	OE_REF0	I	3.3V, active high input pin to enabled REF0
10	OE_REF1	I	3.3V, active high input pin to enabled REF1
11	VSS_SRC	GND	Ground for SRC clocks
12	OE_REF2	I	3.3V, active high input pin to enabled REF2
13	OE_CONF_SE2	I	3.3V, active high input pin to enabled CONF_SE2
14	VDD_SRC	PWR	3.3V Power Supply for SRC clocks
15	SRC1	O, DIF	100MHz True differential serial reference clock
16	SRC1#	O, DIF	100MHz Complement differential serial reference clock
17	SRC2	O, DIF	100MHz True differential serial reference clock
18	SRC2#	O, DIF	100MHz Complement differential serial reference clock
19	SRC3	O, DIF	100MHz True differential serial reference clock
20	SRC3#	O, DIF	100MHz Complement differential serial reference clock
21	VSS_SRC	GND	Ground for SRC clocks
22	VDD_SRC_IO	PWR	Scalable 3.3V to 1.05V Power supply for SRC clocks
23	VSS_SRC	GND	Ground for SRC clocks
24	VDD_SRC_IO	PWR	Scalable 3.3V to 1.05V Power supply for SRC clocks
25	SRC4#	O, DIF	100MHz Complement differential serial reference clock
26	SRC4	O, DIF	100MHz True differential serial reference clock
27	VDD_SRC	PWR	3.3V, Power Supply for SRC clocks
28	SRC5#	O, DIF	100MHz Complement differential serial reference clock
29	SRC5	O, DIF	100MHz True differential serial reference clock
30	VSS_SRC	GND	Ground for SRC clocks
31	SCLK	I	SMBus compatible SCLOCK
32	SDATA	I/O	SMBus compatible SDATA
33	NC	NC	No Connect
34	SRC_EN	I	3.3V, active high input for master enable for all SRC clocks. When set to low, all SRC clocks will be disabled regardless of CLKREQ state.
35	XOUT	O, SE	25.00MHz Crystal output, <i>Float XOUT if using only CLKIN (Clock input)</i>
36	XIN / CLKIN	I	25.00MHz Crystal input or 3.3V, 25MHz Clock Input
37	VSS_REF	GND	Ground for REF clocks
38	REF2	O, SE	3.3V, 25MHz reference output clock
39	REF1	O, SE	25MHz reference output clock
40	REF0	O, SE	25MHz reference output clock
41	VDD_REF	PWR	3.3V, Power Supply for REF clock and power to support WOL

Pin No.	Name	Type	Description
42	CKPWRGD/PD#	I	3.3V LVTTTL input. This pin is a level sensitive strobe used to determine when latch inputs are valid and are ready to be sampled /this pin becomes a real-time active low input for asserting power down (PD#)
43	VDD_SE1	PWR	3.3V Power Supply for CONF_SE1 clock
44	CONF_SE1	O, SE	3.3V, configurable single-ended clock
45	VSS_SE1	GND	Ground for CONF_SE1 clock
46	CLKREQ#1*	I, PU	3.3V, active low input clock request to enable SRC1 (internal 100k-ohm internal pull-up)
47	CLKREQ#2*	I, PU	3.3V, active low input clock request to enable SRC2 (internal 100k-ohm internal pull-up)
48	OE_CONF_SE1	I	3.3V, active high input clock request to enable CONF_SE1

### EProClock® Programmable Technology

EProClock® is the world's first non-volatile programmable clock. The EProClock® technology allows board designer to promptly achieve optimum compliance and clock signal integrity; historically, attainable typically through device and/or board redesigns.

EProClock® technology can be configured through SMBus or hard coded.

#### Features:

- > 4000 bits of configurations
- Can be configured through SMBus or hard coded
- Custom frequency sets

- Differential skew control on true or compliment or both
- Differential duty cycle control on true or compliment or both
- Differential amplitude control
- Differential and single-ended slew rate control
- Program Internal or External series resistor on single-ended clocks
- Programmable different spread profiles
- Programmable modulation rates

### Serial Data Interface

To enhance the flexibility and function of the clock synthesizer, a two-signal serial interface is provided. Through the Serial Data Interface, various device functions, such as individual clock output buffers are individually enabled or disabled. The registers associated with the Serial Data Interface initialize to their default setting at power-up. The use of this interface is optional. Clock device register changes are normally made at system initialization, if any are required. The interface cannot be used during system operation for power management functions.

### Data Protocol

The clock driver serial protocol accepts byte write, byte read, block write, and block read operations from the controller. For block write/read operation, access the bytes in sequential order from lowest to highest (most significant bit first) with the ability to stop after any complete byte is transferred. For byte write and byte read operations, the system controller can access individually indexed bytes. The offset of the indexed byte is encoded in the command code described in *Table 1*.

The block write and block read protocol is outlined in *Table 2* while *Table 3* outlines byte write and byte read protocol. The slave receiver address is 11010010 (D2h).

**Table 1. Command Code Definition**

Bit	Description
7	0 = Block read or block write operation, 1 = Byte read or byte write operation
(6:0)	Byte offset for byte read or byte write operation. For block read or block write operations, these bits should be '000000'

**Table 2. Block Read and Block Write Protocol**

Block Write Protocol		Block Read Protocol	
Bit	Description	Bit	Description
1	Start	1	Start
8:2	Slave address--7 bits	8:2	Slave address--7 bits

**Table 2. Block Read and Block Write Protocol (continued)**

Block Write Protocol		Block Read Protocol	
Bit	Description	Bit	Description
9	Write	9	Write
10	Acknowledge from slave	10	Acknowledge from slave
18:11	Command Code–8 bits	18:11	Command Code–8 bits
19	Acknowledge from slave	19	Acknowledge from slave
27:20	Byte Count–8 bits	20	Repeat start
28	Acknowledge from slave	27:21	Slave address–7 bits
36:29	Data byte 1–8 bits	28	Read = 1
37	Acknowledge from slave	29	Acknowledge from slave
45:38	Data byte 2–8 bits	37:30	Byte Count from slave–8 bits
46	Acknowledge from slave	38	Acknowledge
....	Data Byte /Slave Acknowledges	46:39	Data byte 1 from slave–8 bits
....	Data Byte N–8 bits	47	Acknowledge
....	Acknowledge from slave	55:48	Data byte 2 from slave–8 bits
....	Stop	56	Acknowledge
		....	Data bytes from slave / Acknowledge
		....	Data Byte N from slave–8 bits
		....	NOT Acknowledge
		....	Stop

**Table 3. Byte Read and Byte Write Protocol**

Byte Write Protocol		Byte Read Protocol	
Bit	Description	Bit	Description
1	Start	1	Start
8:2	Slave address–7 bits	8:2	Slave address–7 bits
9	Write	9	Write
10	Acknowledge from slave	10	Acknowledge from slave
18:11	Command Code–8 bits	18:11	Command Code–8 bits
19	Acknowledge from slave	19	Acknowledge from slave
27:20	Data byte–8 bits	20	Repeated start
28	Acknowledge from slave	27:21	Slave address–7 bits
29	Stop	28	Read
		29	Acknowledge from slave
		37:30	Data from slave–8 bits
		38	NOT Acknowledge
		39	Stop

**Control Registers**

**Byte 0: Control Register 0**

Bit	@Pup	Type	Name	Description
7	0	R/W	CONF_SE1_OE	Output Enable for CONF_SE1 0=Disabled, 1=Enabled
6	0	R/W	CONF_SE2_OE	Output Enable for CONF_SE2 0=Disabled, 1=Enabled
5	1	R/W	SRC5_CLKREQ#	Output Enable for SRC5 0=Enabled, 1=Disabled
4	1	R/W	SRC4_CLKREQ#	Output Enable for SRC4 0=Enabled, 1=Disabled
3	1	R/W	SRC3_CLKREQ#	Output Enable for SRC3 0=Enabled, 1=Disabled
2	1	R/W	SRC2_CLKREQ#	Output Enable for SRC2 0=Enabled, 1=Disabled
1	1	R/W	SRC1_CLKREQ#	Output Enable for SRC1 0=Enabled, 1=Disabled
0	1	R/W	SRC_EN	Global Output Enable for SRC[5;1] 0=Disabled, 1=Enabled

**Byte 1: Control Register 1**

Bit	@Pup	Type	Name	Description
7	0	R/W	REF0_OE	Output Enable for REF0 0=Disabled, 1=Enabled
6	0	R/W	REF1_OE	Output Enable for REF1 0=Disabled, 1=Enabled
5	0	R/W	REF2_OE	Output Enable for REF2 0=Disabled, 1=Enabled
4	1	R/W	SRC5_FREERUN	SRC_EN Control for SRC5 0=Free Running, 1=Stoppable by SRC_EN Pin or Bit
3	1	R/W	SRC4_FREERUN	SRC_EN Control for SRC4 0=Free Running, 1=Stoppable by SRC_EN Pin or Bit
2	1	R/W	SRC3_FREERUN	SRC_EN Control for SRC3 0=Free Running, 1=Stoppable by SRC_EN Pin or Bit
1	1	R/W	SRC2_FREERUN	SRC_EN Control for SRC2 0=Free Running, 1=Stoppable by SRC_EN Pin or Bit
0	1	R/W	SRC1_FREERUN	SRC_EN Control for SRC1 0=Free Running, 1=Stoppable by SRC_EN Pin or Bit

**Byte 2: Control Register 2**

Bit	@Pup	Type	Name	Description
7	0	R	Rev Code Bit 3	Revision Code Bit 3
6	0	R	Rev Code Bit 2	Revision Code Bit 2
5	0	R	Rev Code Bit 1	Revision Code Bit 1
4	1	R	Rev Code Bit 0	Revision Code Bit 0
3	1	R	Vendor ID bit 3	Vendor ID Bit 3
2	0	R	Vendor ID bit 2	Vendor ID Bit 2
1	0	R	Vendor ID bit 1	Vendor ID Bit 1
0	0	R	Vendor ID bit 0	Vendor ID Bit 0

**Byte 3: Control Register 3**

Bit	@Pup	Type	Name	Description
7	0	R/W	BC7	Byte count register for block read operation. The default value for Byte count is 8. In order to read more than 8 bytes, the system needs to change this register to the number of bytes to be read.
6	0	R/W	BC6	
5	0	R/W	BC5	
4	0	R/W	BC4	
3	1	R/W	BC3	
2	0	R/W	BC2	
1	0	R/W	BC1	
0	0	R/W	BC0	

**Byte 4: Control Register 4**

Bit	@Pup	Type	Name	Description																				
7	0	R/W	SRC_AMP1	Amplitude Control for SRC clocks																				
6	1	R/W	SRC_AMP0		<table border="1"> <thead> <tr> <th>Byte 4, bit7</th> <th>Byte 4, bit6</th> <th>Amplitude</th> <th>Note</th> </tr> </thead> <tbody> <tr> <td>0</td> <td>0</td> <td>700mV</td> <td></td> </tr> <tr> <td>0</td> <td>1</td> <td>800mV</td> <td>Default</td> </tr> <tr> <td>1</td> <td>0</td> <td>900mV</td> <td></td> </tr> <tr> <td>1</td> <td>1</td> <td>1000mV</td> <td></td> </tr> </tbody> </table>	Byte 4, bit7	Byte 4, bit6	Amplitude	Note	0	0	700mV		0	1	800mV	Default	1	0	900mV		1	1	1000mV
Byte 4, bit7	Byte 4, bit6	Amplitude	Note																					
0	0	700mV																						
0	1	800mV	Default																					
1	0	900mV																						
1	1	1000mV																						
5	0	R/W	CONF_SE1_BIT2	Slew Rate Control for CONF_SE1 and CONF_SE2 clocks																				
4	1	R/W	CONF_SE1_BIT1																					
3	0	R/W	CONF_SE1_BIT0																					
2	0	R/W	CONF_SE2_BIT2																					
1	1	R/W	CONF_SE2_BIT1																					
0	0	R/W	CONF_SE2_BIT0																					

Mode	BIT2	BIT1	BIT0	Buffer Strength
	0	0	0	<div style="text-align: center;"> <p>Strong</p>  <p>Weak</p> </div>
	0	0	1	
Default	0	1	0	
	0	1	1	
	1	0	0	
Wireless Friendly	1	0	1	
	1	1	0	
	1	1	1	

**Byte 5: Control Register 5**

Bit	@Pup	Type	Name	Description																																						
7	0	R/W	REF0_BIT2	Slew Rate Control for REF clocks <table border="1" style="margin-top: 10px;"> <thead> <tr> <th>Mode</th> <th>BIT2</th> <th>BIT1</th> <th>BIT0</th> <th>Buffer Strength</th> </tr> </thead> <tbody> <tr> <td></td> <td>0</td> <td>0</td> <td>0</td> <td rowspan="7" style="text-align: center;">               Strong                ↓                Weak             </td> </tr> <tr> <td></td> <td>0</td> <td>0</td> <td>1</td> </tr> <tr> <td>Default</td> <td>0</td> <td>1</td> <td>0</td> </tr> <tr> <td></td> <td>0</td> <td>1</td> <td>1</td> </tr> <tr> <td></td> <td>1</td> <td>0</td> <td>0</td> </tr> <tr> <td>Wireless Friendly</td> <td>1</td> <td>0</td> <td>1</td> </tr> <tr> <td></td> <td>1</td> <td>1</td> <td>0</td> </tr> <tr> <td></td> <td>1</td> <td>1</td> <td>1</td> </tr> </tbody> </table>	Mode	BIT2	BIT1	BIT0	Buffer Strength		0	0	0	Strong ↓ Weak		0	0	1	Default	0	1	0		0	1	1		1	0	0	Wireless Friendly	1	0	1		1	1	0		1	1	1
Mode	BIT2	BIT1	BIT0		Buffer Strength																																					
	0	0	0		Strong ↓ Weak																																					
	0	0	1																																							
Default	0	1	0																																							
	0	1	1																																							
	1	0	0																																							
Wireless Friendly	1	0	1																																							
	1	1	0																																							
	1	1	1																																							
6	1	R/W	REF0_BIT1																																							
5	0	R/W	REF0_BIT0																																							
4	0	R/W	REF1_BIT2																																							
3	1	R/W	REF1_BIT1																																							
2	0	R/W	REF1_BIT0																																							
1	0	R/W	TEST_MODE_ENTRY	Allows entry into test mode 0 = Normal Operation, 1 = Enter test mode(s)																																						
0	0	R/W	TEST_MODE_SEL	Test mode select either REF/N or tri-state 0 = All outputs tri-state, 1 = All output REF/N																																						

**Byte 6: Control Register 6**

Bit	@Pup	Type	Name	Description																																						
7	0	R/W	REF2_BIT2	Slew Rate Control for REF clocks <table border="1" style="margin-top: 10px;"> <thead> <tr> <th>Mode</th> <th>BIT2</th> <th>BIT1</th> <th>BIT0</th> <th>Buffer Strength</th> </tr> </thead> <tbody> <tr> <td></td> <td>0</td> <td>0</td> <td>0</td> <td rowspan="7" style="text-align: center;">               Strong                ↓                Weak             </td> </tr> <tr> <td></td> <td>0</td> <td>0</td> <td>1</td> </tr> <tr> <td>Default</td> <td>0</td> <td>1</td> <td>0</td> </tr> <tr> <td></td> <td>0</td> <td>1</td> <td>1</td> </tr> <tr> <td></td> <td>1</td> <td>0</td> <td>0</td> </tr> <tr> <td>Wireless Friendly</td> <td>1</td> <td>0</td> <td>1</td> </tr> <tr> <td></td> <td>1</td> <td>1</td> <td>0</td> </tr> <tr> <td></td> <td>1</td> <td>1</td> <td>1</td> </tr> </tbody> </table>	Mode	BIT2	BIT1	BIT0	Buffer Strength		0	0	0	Strong ↓ Weak		0	0	1	Default	0	1	0		0	1	1		1	0	0	Wireless Friendly	1	0	1		1	1	0		1	1	1
Mode	BIT2	BIT1	BIT0		Buffer Strength																																					
	0	0	0		Strong ↓ Weak																																					
	0	0	1																																							
Default	0	1	0																																							
	0	1	1																																							
	1	0	0																																							
Wireless Friendly	1	0	1																																							
	1	1	0																																							
	1	1	1																																							
6	1	R/W	REF2_BIT1																																							
5	0	R/W	REF2_BIT0																																							
4	0	R/W	Wireless Friendly Mode	One-bit slew rate control. Set all SE clocks to 101 setting 0=Disabled; 1=Enabled																																						
3	1	R/W	PLL1_SS_EN	Spread Enabled for PLL1 0=Spread Disabled; 1=Spread Enabled																																						
2	0	R/W	PLL1_SS_DC	Spread Profile 0=-0.5%; 1=+/-0.25%																																						
1	0	R/W	CONF_SE2_FS	CONF_SE2 Frequency Select 0=24.576MHz, 1=12MHz (Note: Byte6<1> only applies when Byte6<0>=0)																																						
0	0	R/W	CONF_SE2_PLL_SEL	PLL source for CONF_SE2 output 0=PLL3; (Note: Byte6<0> = 0, Table 7 applies for CONF_SE2)  1=PLL2; (Note: Byte6<0> = 1, Table 6 applies for CONF_SE2)																																						

**Byte 7: Control Register 7**

Bit	@Pup	Type	Name	Description
7	0	R/W	PLL2_SS_EN	Spread Enabled for PLL2 0=Spread Disabled; 1=Spread Enabled
6	0	R/W	CONFIG_SE1_FS2	See Table 6 on page 7 for full configuraiton
5	0	R/W	CONFIG_SE1_FS1	
4	0	R/W	CONFIG_SE1_FS0	
3	0	R/W	PLL1_PD	Power Down PLL1 0=Enabled PLL1; 1=Disabled PLL1
2	0	R/W	PLL2_PD	Power Down PLL2 0=Enabled PLL2; 1=Disabled PLL2
1	0	R/W	PLL3_PD	Power Down PLL3 0=Enabled PLL3; 1=Disabled PLL3
0	1	R/W	RESET#_SET	RESET# Output setting 0=RESET# output goes low, but will not disabled SRC clocks 1=RESET# goes high after 100ms if device is not in power down or SRC_EN in not "0"

**Input Pins Clarification**

**SRC\_EN Clarification**

SRC\_EN pin is a 3.3V active high input pin. When the SRC\_EN signal is a logic low, all SRC clocks will be disabled synchronously regardless of the CLKREQ# state. If SRC\_EN pin remains disabled it can be re-enabled through the SMBus register. The SRC\_EN signal will be asserted high whenever the SRC\_EN pin or the SRC\_EN bit is a logic high.

**CLKREQ# Clarification**

The CLKREQ# signals are active low inputs used to cleanly enable and disable selected SRC outputs. If CLKREQ# pin remains disabled it can be re-enabled through the SMBus register. The CLKREQ# signal will be asserted high whenever the CLKREQ# pin or the CLKREQ# bit is a logic high.

**OE Clarification**

The OE signals are active high inputs used to enable and disable single-ended outputs. If OE pin remains disabled it can be re-enabled through the SMBus register. The OE signal will be asserted high whenever the OE pin or the OE bit is a logic high. OE pins is required to be driven at all time.

**RESET# Clarification**

The RESET# signal is 3.3V output signal with an internal 100k-ohm pull-down. The RESET# output is low during power up. When SRC\_EN is low and after all SRC clocks go low, RESET# will go low. If any of the SRCs is running when SRC\_EN is low, RESET# will not go low. When PD pin is de-asserted and SRC\_EN goes high, RESET# will remain low for 100ms then goes high. If PD is asserted, RESET# will be low.

**Table 4. CLKREQ# Table for SRC Clocks**

CKPWRGD / PD#	SRC_EN Pin	SRC_EN Bit	CLKREQ# Pin	CLKREQ# Bit	SRC Clocks
1	1	X	0	X	Enabled
1	1	X	X	0	Enabled
1	X	1	0	X	Enabled
1	X	1	X	0	Enabled
1	0	0	0	0	Disabled if not free running
1	0	0	0	1	Disabled if not free running
1	0	0	1	0	Disabled if not free running
1	X	X	1	1	Disabled
0	X	X	X	X	Disabled



**Table 5. Output Enable Table For Singled-Ended Clock**

CKPWRGD / PD#	OE Pin	OE Bit	Singled Ended Clocks
1	X	1	Enabled
1	1	X	Enabled
1	0	0	Disabled
0	X	X	Disabled

**Table 6. Frequency and Spread Table for CONF\_SE1 (and CONF\_SE2 if Byte6<0> = 1)**

Byte 7, bit 7	Byte 7, bit 6	Byte 7, bit 5	Byte 7, bit 4	CONF_SE1 Clock (Pin 44)	CONF_SE1 Spread	Note
0	0	0	0	27MHz	no spread	Default
0	0	0	1	12MHz	no spread	
0	0	1	0	25MHz	no spread	25MHz REF output is used for CONF_SE1. PLL2 is disabled. This selection is not applicable to CONF_SE2 output.
0	0	1	1	33MHz	no spread	
0	1	0	0	24MHz	no spread	
0	1	0	1	48MHz	no spread	
0	1	1	0	30MHz	no spread	
0	1	1	1	24.576MHz	no spread	
1	0	0	0	27MHz	-0.50%	
1	0	0	1	27MHz	-0.75%	
1	0	1	0	27MHz	-1.0%	
1	0	1	1	27MHz	-1.5%	
1	1	0	0	27MHz	+/-0.5%	
1	1	0	1	27MHz	+/-0.25%	
1	1	1	0	33MHz	-0.5%	
1	1	1	1	33MHz	+/-0.25%	

**Table 7. Frequency and Spread Table for CONF\_SE2 when Byte6<0> = 0**

Byte 6, bit 1	CONF_SE2 Clock (Pin 7)	CONF_SE2 Spread	Note
0	24.576MHz	no spread	Default
1	12MHz	no spread	

**Absolute Maximum Conditions**

Parameter	Description	Condition	Min.	Max.	Unit
V <sub>DD_3.3V</sub>	Main Supply Voltage	Functional	-	4.6	V
V <sub>DD_IO</sub>	IO Supply Voltage	Functional	-	3.465	V
V <sub>IN</sub>	Input Voltage	Relative to V <sub>SS</sub>	-0.5	4.6	V <sub>DC</sub>
T <sub>S</sub>	Temperature, Storage	Non-functional	-65	150	°C
T <sub>AI(INDUSTRIAL)</sub>	Temperature, Operating Ambient	Functional	-40	85	°C
T <sub>A(COMMERCIAL)</sub>	Temperature, Operating Ambient	Functional	0	85	°C
T <sub>J</sub>	Temperature, Junction	Functional	-	150	°C
∅ <sub>JC</sub>	Dissipation, Junction to Case	JEDEC (JESD 51)	-	20	°C/W

**Absolute Maximum Conditions**

$\theta_{JA}$	Dissipation, Junction to Ambient	JEDEC (JESD 51)	–	60	°C/W
ESD <sub>HBM</sub>	ESD Protection (Human Body Model)	JEDEC (JESD 22 - A114)	2000	–	V
UL-94	Flammability Rating	UL (Class)	V-0		

**Multiple Supplies:** The Voltage on any input or I/O pin cannot exceed the power pin during power-up. Power supply sequencing is NOT required.

**DC Electrical Specifications**

Parameter	Description	Condition	Min.	Max.	Unit
VDD core	3.3V Operating Voltage	3.3 ± 5%	3.135	3.465	V
V <sub>IH</sub>	3.3V Input High Voltage (SE)		2.0	V <sub>DD</sub> + 0.3	V
V <sub>IL</sub>	3.3V Input Low Voltage (SE)		V <sub>SS</sub> – 0.3	0.8	V
V <sub>IH12C</sub>	Input High Voltage	SDATA, SCLK	2.2	–	V
V <sub>IL12C</sub>	Input Low Voltage	SDATA, SCLK	–	1.0	V
V <sub>IH_CTRL_INPUT</sub>	Input High Voltage	Applies to all input and latched pins	0.7	VDD+0.3	V
V <sub>IL_CTRL_INPUT</sub>	Input Low Voltage	Applies to all input and latched pins	V <sub>SS</sub> – 0.3	0.35	V
I <sub>IH</sub>	Input High Leakage Current	Except internal pull-down resistors, 0 < V <sub>IN</sub> < V <sub>DD</sub>	–	5	μA
I <sub>IL</sub>	Input Low Leakage Current	Except internal pull-up resistors, 0 < V <sub>IN</sub> < V <sub>DD</sub>	–5	–	μA
V <sub>OH</sub>	3.3V Output High Voltage (SE)	I <sub>OH</sub> = –1 mA	2.4	–	V
V <sub>OL</sub>	3.3V Output Low Voltage (SE)	I <sub>OL</sub> = 1 mA	–	0.4	V
I <sub>OZ</sub>	High-impedance Output Current		–10	10	μA
C <sub>IN</sub>	Input Pin Capacitance		1.5	5	pF
C <sub>OUT</sub>	Output Pin Capacitance			6	pF
L <sub>IN</sub>	Pin Inductance		–	7	nH
V <sub>XIH</sub>	Xin High Voltage		0.7V <sub>DD</sub>	V <sub>DD</sub>	V
V <sub>XIL</sub>	Xin Low Voltage		0	0.3V <sub>DD</sub>	V
I <sub>DD_PWR_DW</sub>	Power Down Current		–	1	mA
I <sub>DD_3.3V</sub>	Dynamic Supply Current	Default Power on, all clock active, C <sub>L</sub> =0	–	50	mA
I <sub>DD_1.05V</sub>	Dynamic Supply Current	Default Power on, all clock active, C <sub>L</sub> =0	–	5	mA

**AC Electrical Specifications**

Parameter	Description	Condition	Min.	Max.	Unit
<b>Crystal</b>					
L <sub>ACC</sub>	Long-term Accuracy	Measured at VDD/2 differential	–	250	ppm
<b>Clock Input</b>					
T <sub>DC</sub>	CLKIN Duty Cycle	Measured at VDD/2	47	53	%
T <sub>R</sub> /T <sub>F</sub>	CLKIN Rise and Fall Times	Measured between 0.2V <sub>DD</sub> and 0.8V <sub>DD</sub>	0.5	4.0	V/ns
T <sub>CCJ</sub>	CLKIN Cycle to Cycle Jitter	Measured at VDD/2	–	250	ps
T <sub>LTJ</sub>	CLKIN Long Term Jitter	Measured at VDD/2	–	350	ps
V <sub>IL</sub>	Input Low Voltage	XIN / CLKIN pin	–	0.8	V
V <sub>IH</sub>	Input High Voltage	XIN / CLKIN pin	2	VDD+0.3	V
I <sub>IL</sub>	Input Low Current	XIN / CLKIN pin, 0 < V <sub>IN</sub> < 0.8	–	20	uA
I <sub>IH</sub>	Input High Current	XIN / CLKIN pin, V <sub>IN</sub> = VDD	–	35	uA
<b>SRC at 0.7V</b>					
T <sub>DC</sub>	Duty Cycle	Measured at 0V differential	45	55	%
T <sub>CCJ</sub>	Cycle to Cycle Jitter	Measured at 0V differential	–	125	ps
RMS <sub>GEN1</sub>	Output PCIe* Gen1 REFCLK phase jitter	BER = 1E-12 (including PLL BW 8 - 16 MHz, ζ = 0.54, Td=10 ns, Ftrk=1.5 MHz)	0	108	ps
RMS <sub>GEN2</sub>	Output PCIe* Gen2 REFCLK phase jitter	Includes PLL BW 8 - 16 MHz, Jitter Peaking = 3dB, ζ = 0.54, Td=10 ns), Low Band, F < 1.5MHz	0	3.0	ps
RMS <sub>GEN2</sub>	Output PCIe* Gen2 REFCLK phase jitter	Includes PLL BW 8 - 16 MHz, Jitter Peaking = 3dB, ζ = 0.54, Td=10 ns), Low Band, F < 1.5MHz	0	3.1	ps
L <sub>ACC</sub>	Long Term Accuracy	Measured at 0V differential	–	100	ppm
T <sub>R</sub> / T <sub>F</sub>	Rising/Falling Slew Rate	Measured differentially from ±150 mV	2.5	8	V/ns
<b>CONFI_SE1 &amp; CONF_SE2 at 3.3V</b>					
T <sub>DC</sub>	Duty Cycle	Measurement at 1.5V	45	55	%
T <sub>R</sub> / T <sub>F</sub> (48M)	Rising and Falling Edge Rate	Measured between 0.8V and 2.0V	1.0	4.0	V/ns
T <sub>CCJ</sub>	Cycle to Cycle Jitter	Measurement at 1.5V	–	300	ps
L <sub>ACC</sub>	Long Term Accuracy	Measurement at 1.5V	–	100	ppm
<b>25M at 3.3V</b>					
T <sub>DC</sub>	Duty Cycle	Measurement at 1.5V	45	55	%
T <sub>R</sub> / T <sub>F</sub>	Rising and Falling Edge Rate	Measured between 0.8V and 2.0V	1.0	4.0	V/ns
T <sub>CCJ</sub>	Cycle to Cycle Jitter	Measurement at 1.5V	–	300	ps
L <sub>ACC</sub>	Long Term Accuracy	Measured at 1.5V	–	100	ppm
<b>ENABLE/DISABLE and SET-UP</b>					
T <sub>STABLE</sub>	Clock Stabilization from Power-up		–	1.8	ms
T <sub>STABLE</sub>	Clock Stabilization from CLKREQ and Output Enable		–	1.0	ms
T <sub>SS</sub>	Stopclock Set-up Time		10.0	–	ns

**Test and Measurement Set-up**

**For Single Ended Clocks**

The following diagram shows the test load configurations for the single-ended output signals.

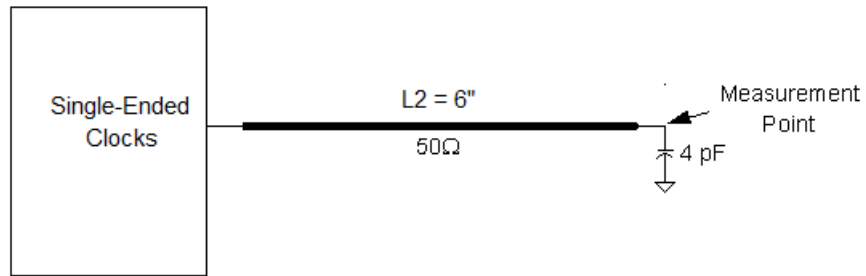

**Figure 1. Single-ended clocks Single Load Configuration**

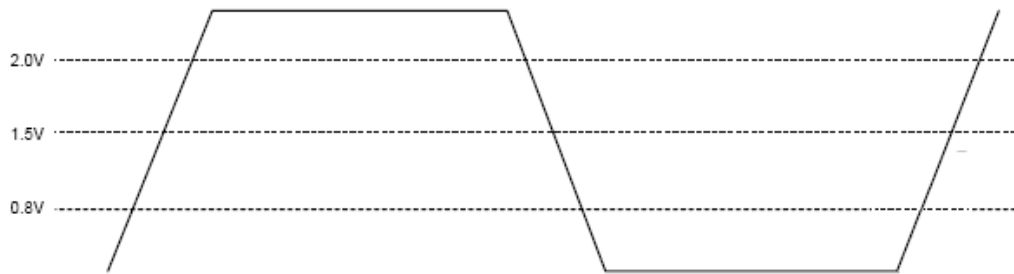

**Figure 2. Single-ended Output Signals (for AC Parameters Measurement)**

**For Differential Clock Signals**

This diagram shows the test load configuration for the differential clock signals

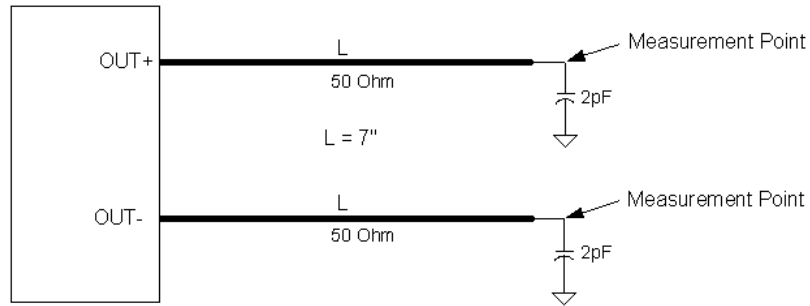

**Figure 3. 0.7V Differential Load Configuration**

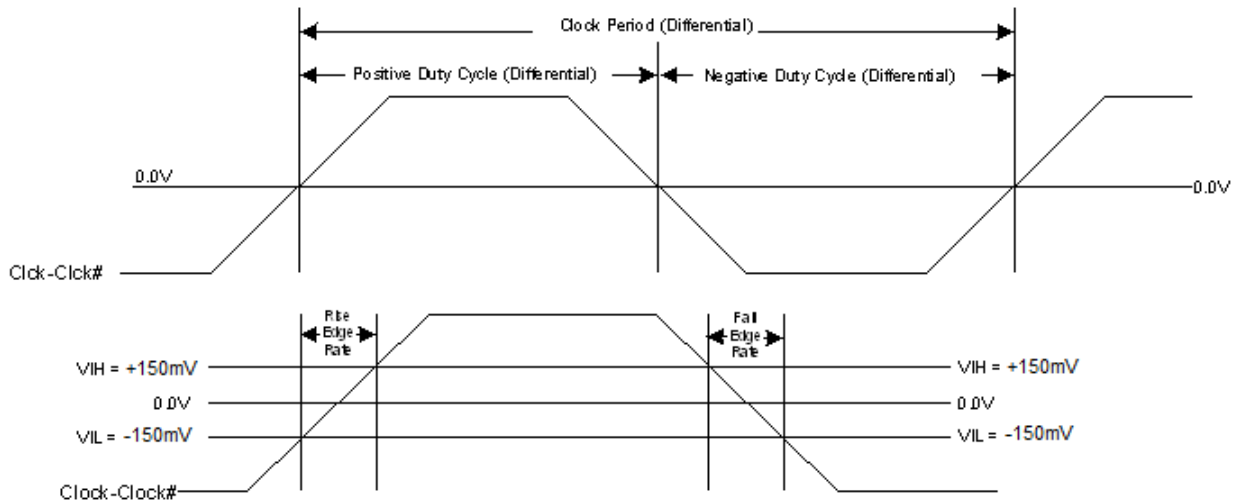

**Figure 4. Differential Measurement for Differential Output Signals (for AC Parameters Measurement)**

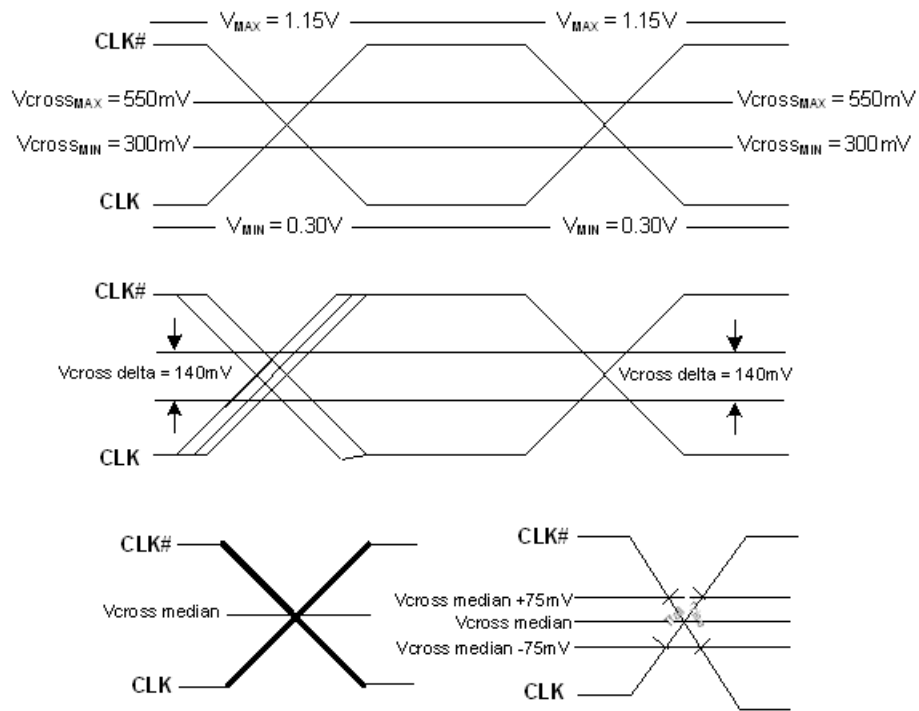

Figure 5. Single-ended Measurement for Differential Output Signals (for AC Parameters Measurement)

Document History Page

Ordering Information

Part Number	Package Type	Product Flow
<b>Lead-free</b>		
SL28PCIe50LC	48-pin QFN	Commercial, 0° to 85°C
SL28PCIe50LCT	48-pin QFN – Tape and Reel	Commercial, 0° to 85°C
SL28PCIe50LI	48-pin QFN	Industrial, -40° to 85°C
SL28PCIe50LIT	48-pin QFN – Tape and Reel	Industrial, -40° to 85°C

Package Diagrams

48-Lead QFN 6 x 6mm

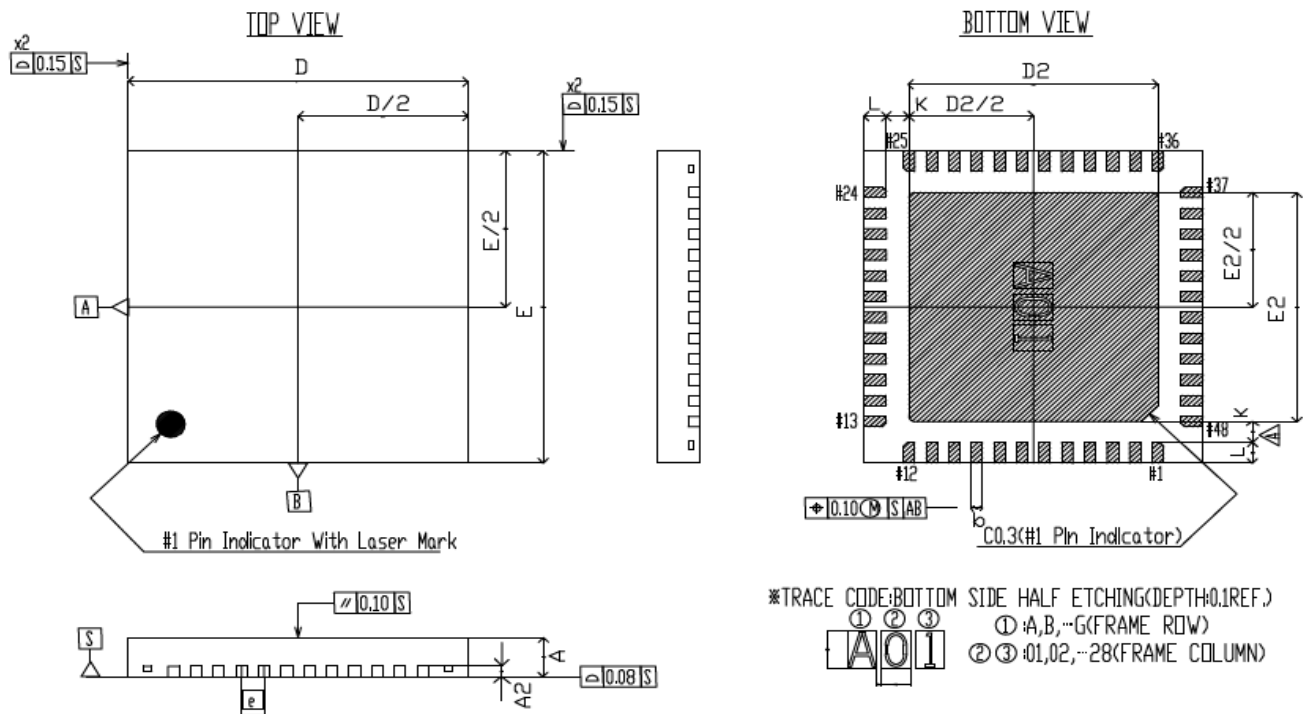

SYMBOL	COMMON DIMENSIONS		
	MIN	NOM	MAX
A	0.70	0.75	0.80
A2	0.20 REF.		
b	0.15	0.20	0.25
D	5.90	6.00	6.10
D2	4.25	4.40	4.55
E	5.90	6.00	6.10
E2	4.25	4.40	4.55
e	0.40 BSC.		
k	0.36	—	—
L	0.30	0.40	0.50

- NOTES)  
 1. ALL DIMENSIONS ARE IN MILLIMETERS.  
 2. DIMENSIONAL TOLERANCE UNLESS OTHERWISE SPECIFIED  
 3. THE SURFACE OF THE PACKAGE SHALL BE RZ 4-8µm.  
 4. PROTRUSIONS AT PKG. OUTLINE SHALL NOT EXCEED 0.10.

<b>Document Title: SL28PCle50 PC EProClock® Generator</b>			
<b>DOC#: SP-AP-0758 (Rev. AA)</b>			
<b>REV.</b>	<b>Issue Date</b>	<b>Orig. of Change</b>	<b>Description of Change</b>
AA	03/06/11	JMA	Initial Release





## ClockBuilder Pro

One-click access to Timing tools, documentation, software, source code libraries & more. Available for Windows and iOS (CBGo only).

[www.silabs.com/CBPro](http://www.silabs.com/CBPro)



Timing Portfolio  
[www.silabs.com/timing](http://www.silabs.com/timing)



SW/HW  
[www.silabs.com/CBPro](http://www.silabs.com/CBPro)



Quality  
[www.silabs.com/quality](http://www.silabs.com/quality)



Support and Community  
[community.silabs.com](http://community.silabs.com)

### Disclaimer

Silicon Laboratories intends to provide customers with the latest, accurate, and in-depth documentation of all peripherals and modules available for system and software implementers using or intending to use the Silicon Laboratories products. Characterization data, available modules and peripherals, memory sizes and memory addresses refer to each specific device, and "Typical" parameters provided can and do vary in different applications. Application examples described herein are for illustrative purposes only. Silicon Laboratories reserves the right to make changes without further notice and limitation to product information, specifications, and descriptions herein, and does not give warranties as to the accuracy or completeness of the included information. Silicon Laboratories shall have no liability for the consequences of use of the information supplied herein. This document does not imply or express copyright licenses granted hereunder to design or fabricate any integrated circuits. The products are not designed or authorized to be used within any Life Support System without the specific written consent of Silicon Laboratories. A "Life Support System" is any product or system intended to support or sustain life and/or health, which, if it fails, can be reasonably expected to result in significant personal injury or death. Silicon Laboratories products are not designed or authorized for military applications. Silicon Laboratories products shall under no circumstances be used in weapons of mass destruction including (but not limited to) nuclear, biological or chemical weapons, or missiles capable of delivering such weapons.

### Trademark Information

Silicon Laboratories Inc.®, Silicon Laboratories®, Silicon Labs®, SiLabs® and the Silicon Labs logo®, Bluegiga®, Bluegiga Logo®, Clockbuilder®, CMEMS®, DSPLL®, EFM®, EFM32®, EFR®, Ember®, Energy Micro, Energy Micro logo and combinations thereof, "the world's most energy friendly microcontrollers", Ember®, EZLink®, EZRadio®, EZRadioPRO®, Gecko®, ISOModem®, Precision32®, ProSLIC®, Simplicity Studio®, SiPHY®, Telegesis, the Telegesis Logo®, USBXpress® and others are trademarks or registered trademarks of Silicon Laboratories Inc. ARM, CORTEX, Cortex-M3 and THUMB are trademarks or registered trademarks of ARM Holdings. Keil is a registered trademark of ARM Limited. All other products or brand names mentioned herein are trademarks of their respective holders.



Silicon Laboratories Inc.  
400 West Cesar Chavez  
Austin, TX 78701  
USA

<http://www.silabs.com>